

## Primax

Synonymous with function and performance, enter the Primax, the new era of high intensity illumination in LED. With its high flux output and high luminous intensity, Primax transcends today LED lightings technology and how we perceive it. The small package outline and high intensity make it an ideal choice for backlighting, signage, exterior automotive lighting and decorative lighting.



## Features:

- > Super high brightness surface mount LED
- > 120° viewing angle.
- > Compact package outline (LxW) of 3.7 x 3.5 mm.
- > Ultra low height profile - 0.8mm.
- > Low thermal resistance.
- > Compatible to IR reflow soldering.
- > Superior corrosion resistant.
- > Environmental friendly; RoHS compliance.
- > Compliance to automotive standard; AEC-Q102.

## Applications:

- > Automotive: exterior applications, eg: signal lighting, Center High Mounted Stop Light (CHMSL), Rear Combination Lamp (RCL), Rear Fog Lamp.

**Optical Characteristics at Tj=25°C**

Part Number	Color, $\lambda_{dom}$ (nm)		Viewing Angle°	Luminous Flux @ 140mA (lm) <i>Appx. 1.2</i>					
	Chip #1	Chip #2		Chip #1		Chip #2			
				Min.	Typ.	Max.	Min.	Typ.	Max.
MCSZY-VZHG-LM3+P3R2-3+1	Super Red, 635nm	InGaN Yellow	120	10.7	13.9	18.1	26.8	36.0	45.2
MCSZY-VZHG-L3N+P3R2-2+1	Super Red, 630nm	InGaN Yellow	120	12.2	18.1	23.5	26.8	36.0	45.2
● MCSZY-VZHG-LM3+PQ3-3+1	Super Red, 635nm	InGaN Yellow	120	10.7	13.9	18.1	23.5	30.6	39.8
● MCSZY-VZHG-L3N+PQ3-2+1	Super Red, 630nm	InGaN Yellow	120	12.2	18.1	23.5	23.5	30.6	39.8
MCAZY-VZHG-PQ3+P3R2-2+1	Amber, 615nm	InGaN Yellow	120	23.5	30.6	39.8	26.8	36.0	45.2
MCAZY-VZHG-NQ2+P3R2-4+1	Amber, 624nm	InGaN Yellow	120	18.1	23.5	34.8	26.8	36.0	45.2
● MCAZY-VZHG-PQ3+PQ3-2+1	Amber, 615nm	InGaN Yellow	120	23.5	30.6	39.8	23.5	30.6	39.8
● MCAZY-VZHG-NQ2+PQ3-4+1	Amber, 624nm	InGaN Yellow	120	18.1	23.5	34.8	23.5	30.6	39.8

● Not for new design

**Electrical Characteristics at Tj=25°C**

Part Number	Vf @ If = 140 mA <i>Appx. 3.1</i>		
	Min. (V)	Typ. (V)	Max. (V)
Super Red / Amber	1.90	2.30	2.50
InGaN Yellow	2.80	3.10	3.40

**Absolute Maximum Ratings**

	Maximum Value	Unit
DC forward current	200	mA
Peak pulse current (Ts = 55°C, tp ≤ 100µs , Duty cycle = 0.03)	300	mA
Reverse Voltage	Not designed for reverse bias	V
ESD threshold (HBM)	8	kV
LED junction temperature	150	°C
Operating temperature	-40 ... +125	°C
Storage temperature	-40 ... +125	°C
Thermal resistance - Super Red / Amber (Rated current = 140mA, Ts=25°C)		
- Real Thermal Resistance		
Junction / solder point, R <sub>th JS real</sub> (Typ = 30K/W)	40	K/W
- Electrical Thermal Resistance		
Junction / solder point, R <sub>th JS el</sub> (Typ = 24K/W)	32	K/W
Thermal resistance - InGaN Yellow (Rated current = 140mA, Ts=25°C)		
- Real Thermal Resistance		
Junction / solder point, R <sub>th JS real</sub> (Typ = 14K/W)	20	K/W
- Electrical Thermal Resistance		
Junction / solder point, R <sub>th JS el</sub> (Typ = 12K/W)	18	K/W

**Wavelength Grouping at Tj=25°C**

Color	Group	Wavelength distribution (nm) <small>Appx. 2.2</small>
Super Red	Full	627 - 637
	W	627 - 630
	X	630 - 634
	Y	634 - 637
Amber	Full	612 - 627
	W	612 - 616
	X	616 - 620
	Y	620 - 624
	Z	624 - 627

**MCxZY-VZHG, InGaN Yellow Color Grouping** *Appx. 2.1*

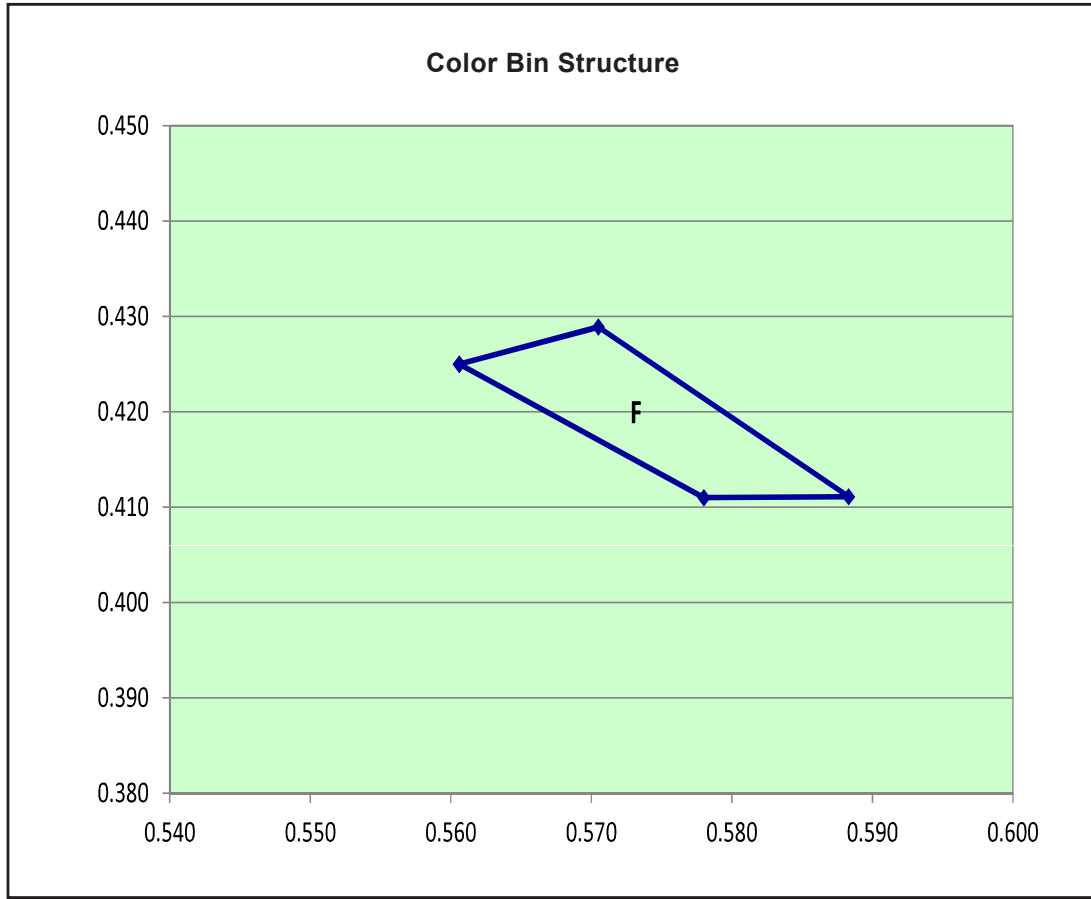

Bin		1	2	3	4
F	Cx	0.5606	0.5705	0.5883	0.5780
	Cy	0.4250	0.4289	0.4111	0.4110

InGaN wavelength is very sensitive to drive current. Operating at lower current is not recommended and may yield unpredictable performance current pulsing should be used for dimming purposed.

**Luminous Flux at Tj=25°C**

Brightness Group	Luminous Flux @ If=140mA (lm) <i>Appx. 1.2</i>
L2	10.7 ... 12.2
L3	12.2 ... 13.9
M2	13.9 ... 15.8
M3	15.8 ... 18.1
N2	18.1 ... 20.6
N3	20.6 ... 23.5
P2	23.5 ... 26.8
P3	26.8 ... 30.6
Q2	30.6 ... 34.8
Q3	34.8 ... 39.8
R2	39.8 ... 45.2

**Vf Binning (Optional)**

Vf Bin @ 140mA	Forward Voltage (V) <i>Appx. 3.1</i>
43	1.90 ... 2.05
44	2.05 ... 2.20
45	2.20 ... 2.35
46	2.35 ... 2.50
Vf Bin @ 140mA	Forward Voltage (V) <i>Appx. 3.1</i>
R7	2.80 ... 3.10
R8	3.10 ... 3.40

Please consult sales and marketing for special part number to incorporate Vf binning.

**Relative Luminous Flux Vs Forward Current** *Appx. 4.1*

$\Phi_V / \Phi_V(140\text{mA}) = f(I_F); T_j = 25^\circ\text{C}$

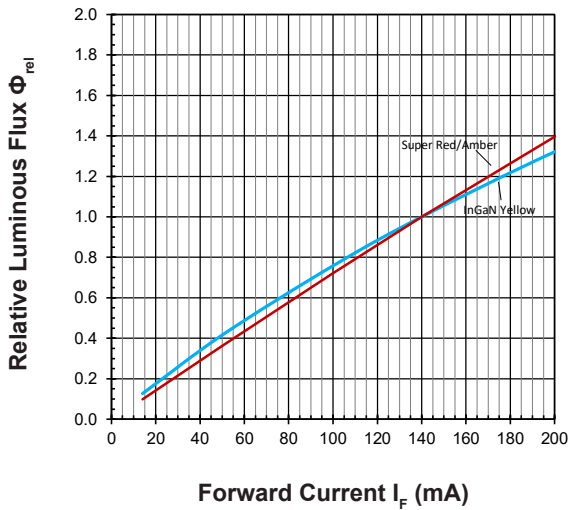

**Forward Current Vs Forward Voltage** *Appx. 4.1*

$I_F = f(V_F); T_j = 25^\circ\text{C}$

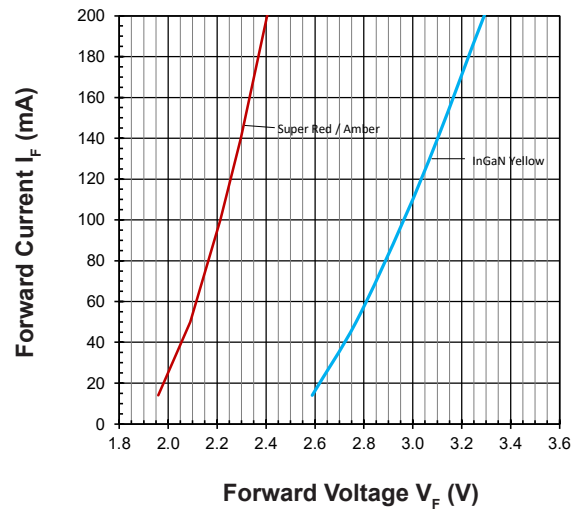

**Maximum Current Vs Temperature**

$I_F = f(T)$

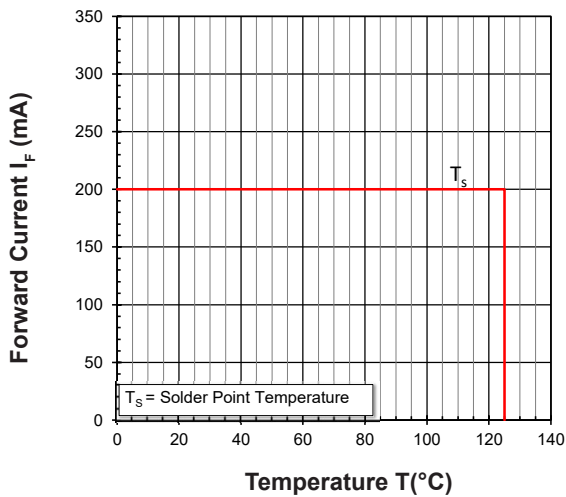

**Relative Spectral Emission** *Appx. 4.1*

$\Phi_{rel} = f(\lambda); T_j = 25^\circ\text{C}; I_F = 140\text{mA}$

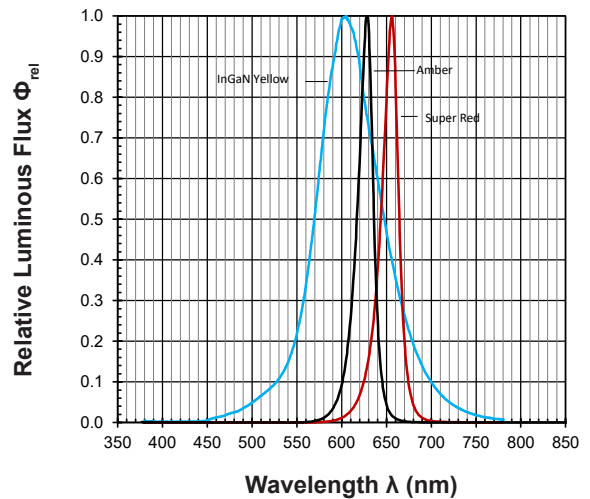

**Chromaticity Coordinate Shift Vs Forward Current** *Appx. 4.1*

$\Delta Cx, \Delta Cy = f(I_F); T_j = 25^\circ\text{C}$  (InGaN Yellow)

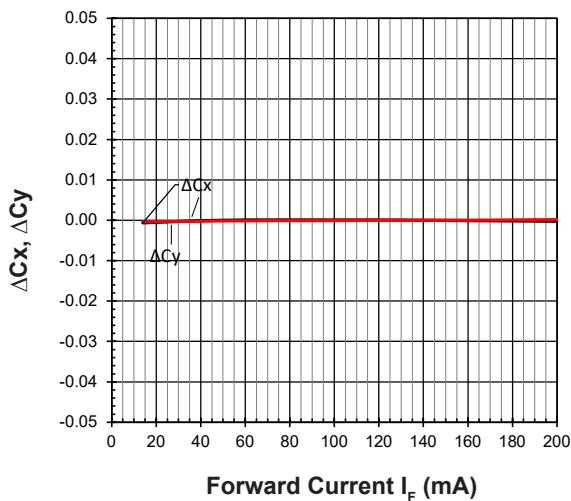

**Allowable Forward Current Vs Duty Ratio**

( $T_s = 55^\circ\text{C}; t_p \leq 100\mu\text{s}$ )

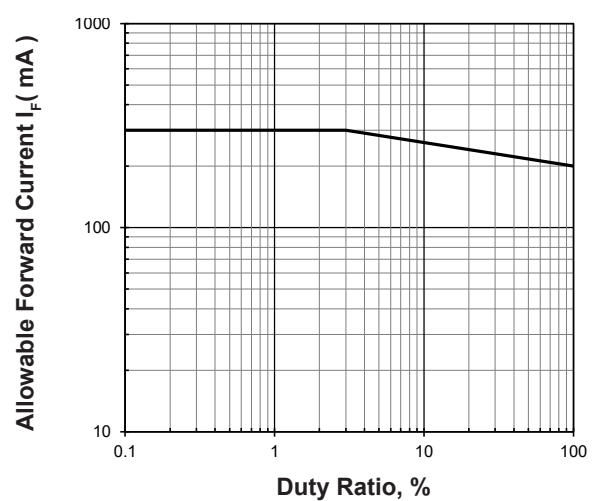

**Radiation Pattern** *Appx. 4.1*

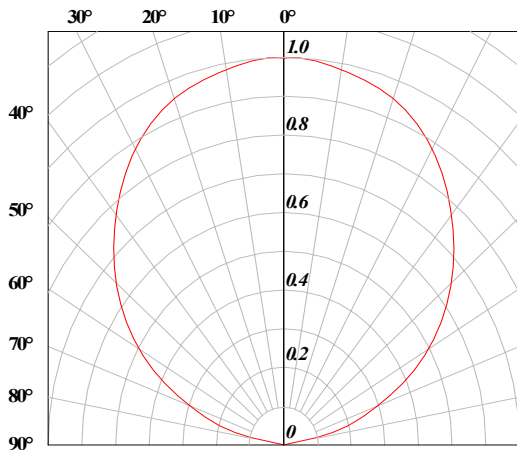

**Forward Voltage Vs Junction Temperature** *Appx. 4.1*

$$\Delta V_F = V_F - V_F(25^\circ\text{C}) = f(T_j); I_F = 140\text{mA}$$

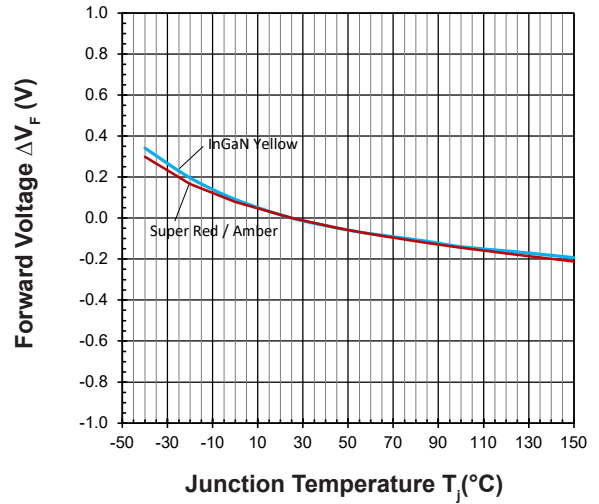

**Relative Luminous Flux Vs Junction Temperature** *Appx. 4.1*

$$\Phi_V/\Phi_V(25^\circ\text{C}) = f(T_j); I_F = 140\text{mA}$$

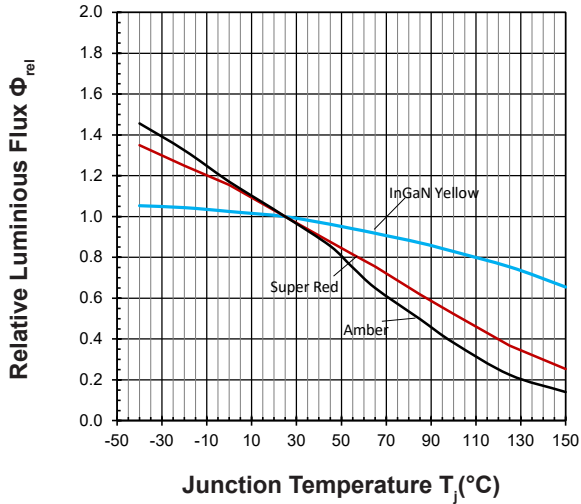

**Wavelength Vs Junction Temperature** *Appx. 4.1*

$$\Delta \lambda_{dom} = \lambda_{dom} - \lambda_{dom}(25^\circ\text{C}) = f(T_j); I_F = 140\text{mA}$$

(Super Red & Amber)

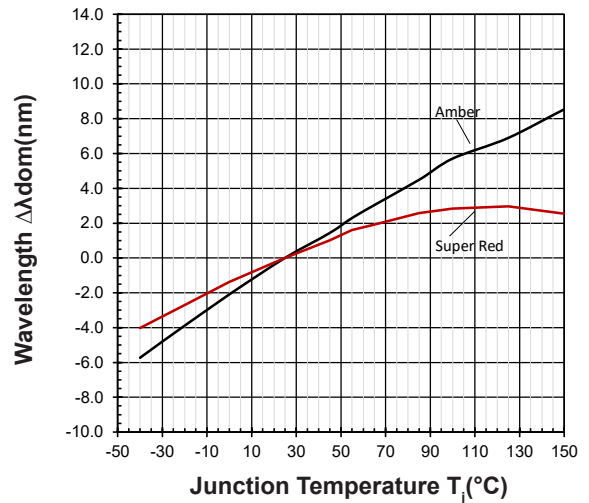

**Chromaticity Coordinate Shift Vs Junction Temperature** *Appx. 4.1*

$$\Delta Cx, \Delta Cy = f(T_j); I_F = 140\text{mA (InGaN Yellow)}$$

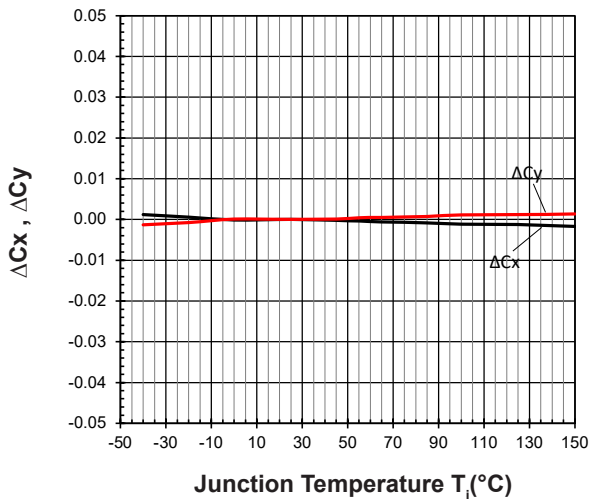

**PrimaxPlus Bi-Color • AllInGaP & InGaN: MCxZY-VZHG Package Outlines** *Appx. 5.1*

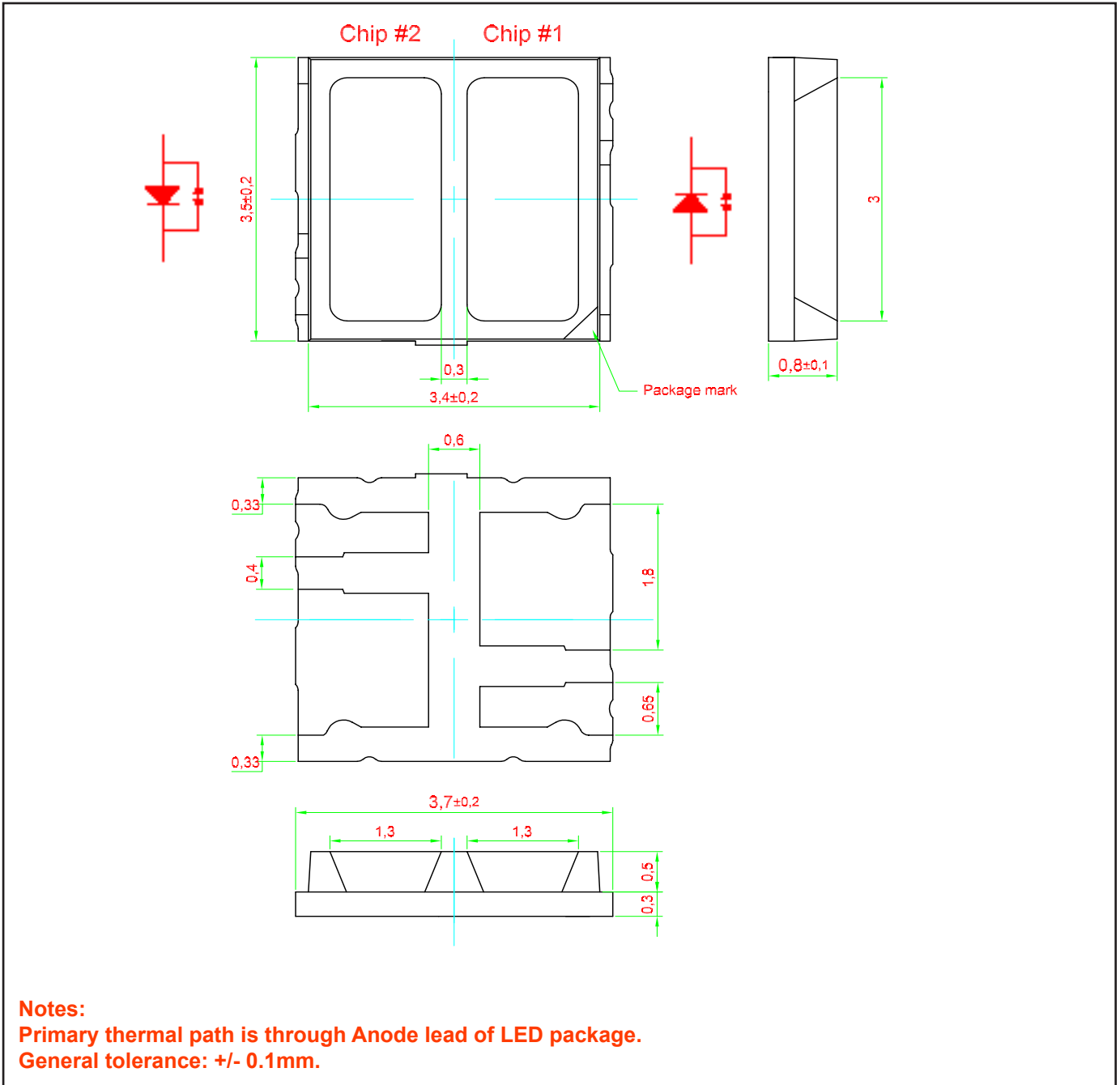

**Material**

Material	
Lead-frame	Cu Alloy With Au Plating
Package	High Temperature Resistant Plastic
Encapsulant	Silicone Resin
Soldering Leads	Au Plating

**Recommended Solder Pad** *Appx. 5.1*

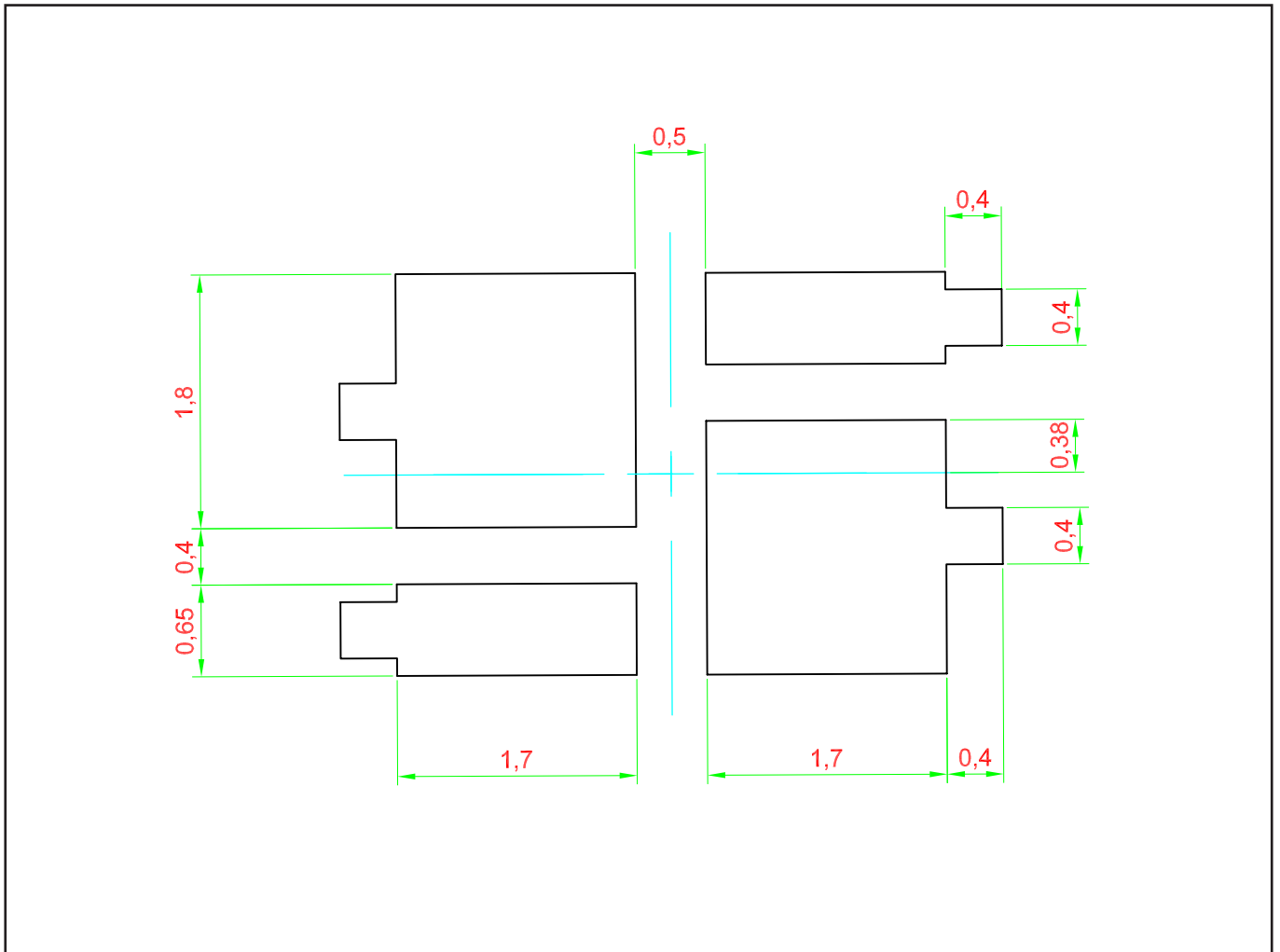

Taping and orientation *Appx. 5.1*

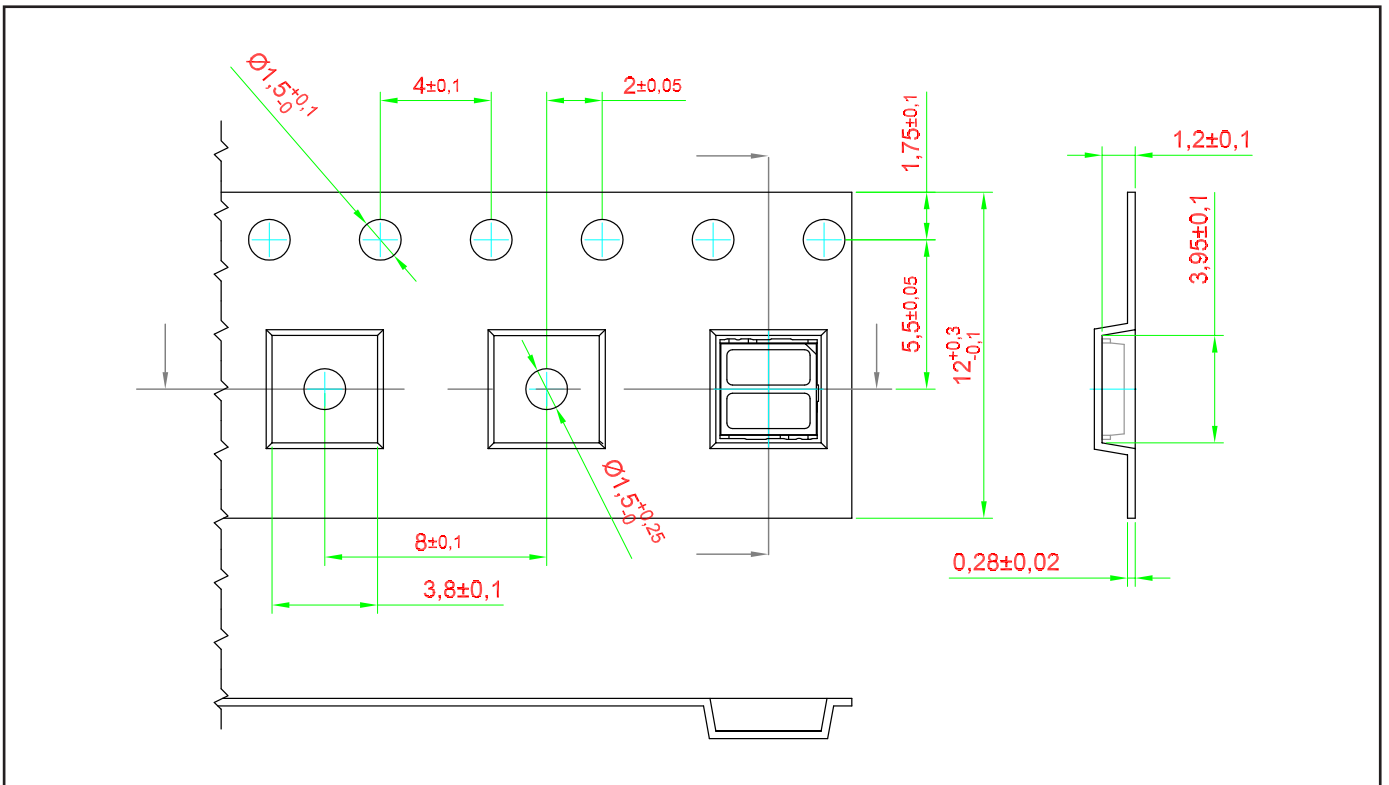

**Packaging Specification**

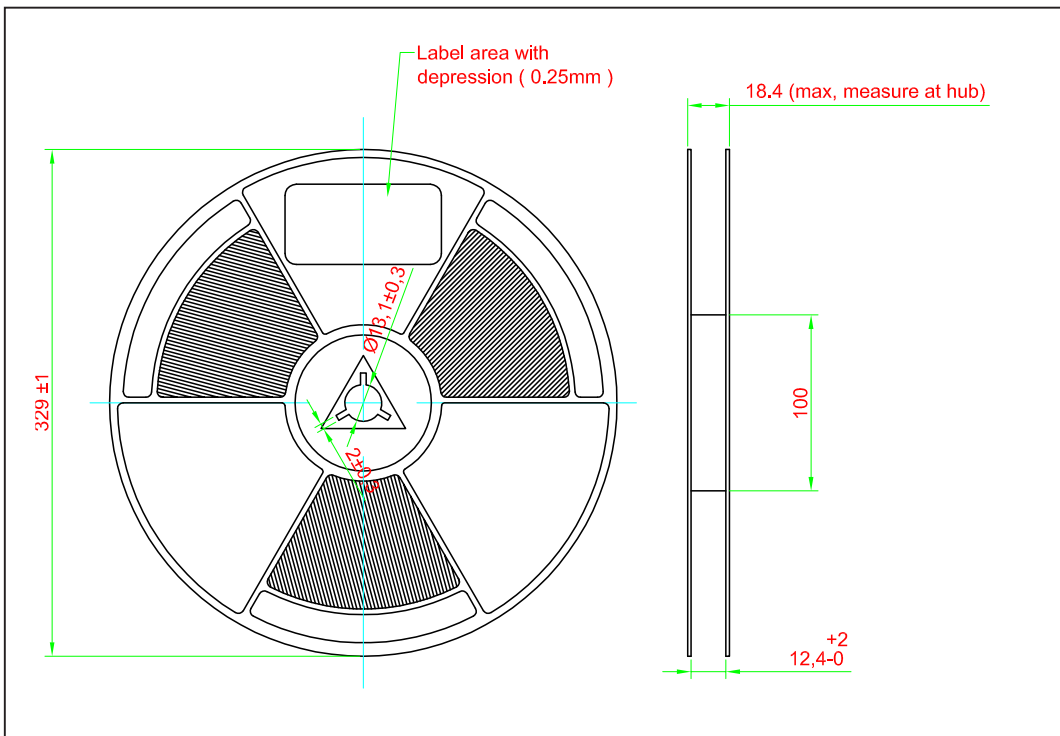
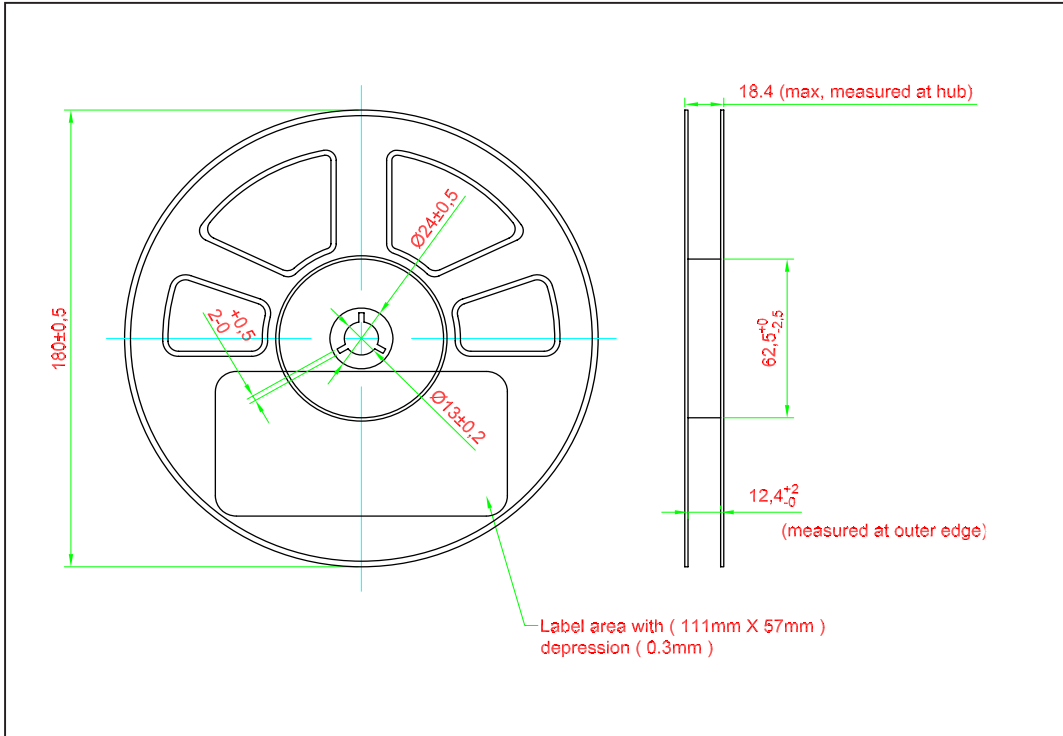

	Reel Diameter (mm)	Quantity (pcs)	*Ordering Number
Standard Packing	180	1500	MCxZY-VZHG-xxx+xxx-x+x
Optional Packing	329	5000	MCxZY-VZHG-xxx+xxx-x+x-5

Notes:

\* For ordering purpose only. Please consult sales and marketing for details.

**Packaging Specification**

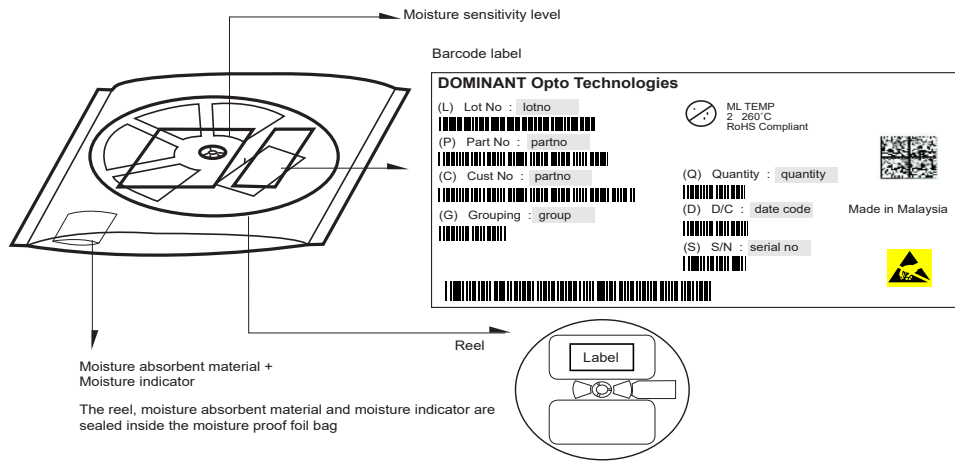

Quantity per bag (pcs)	Average 1pc PrimaxPlus (g)	1 completed bag (g)
1500	0.034	245 ± 10
5000	0.034	1150 ± 10

## Recommended Pb-free Soldering Profile

Product complies to MSL Level 2 acc. to JEDEC J-STD-020E

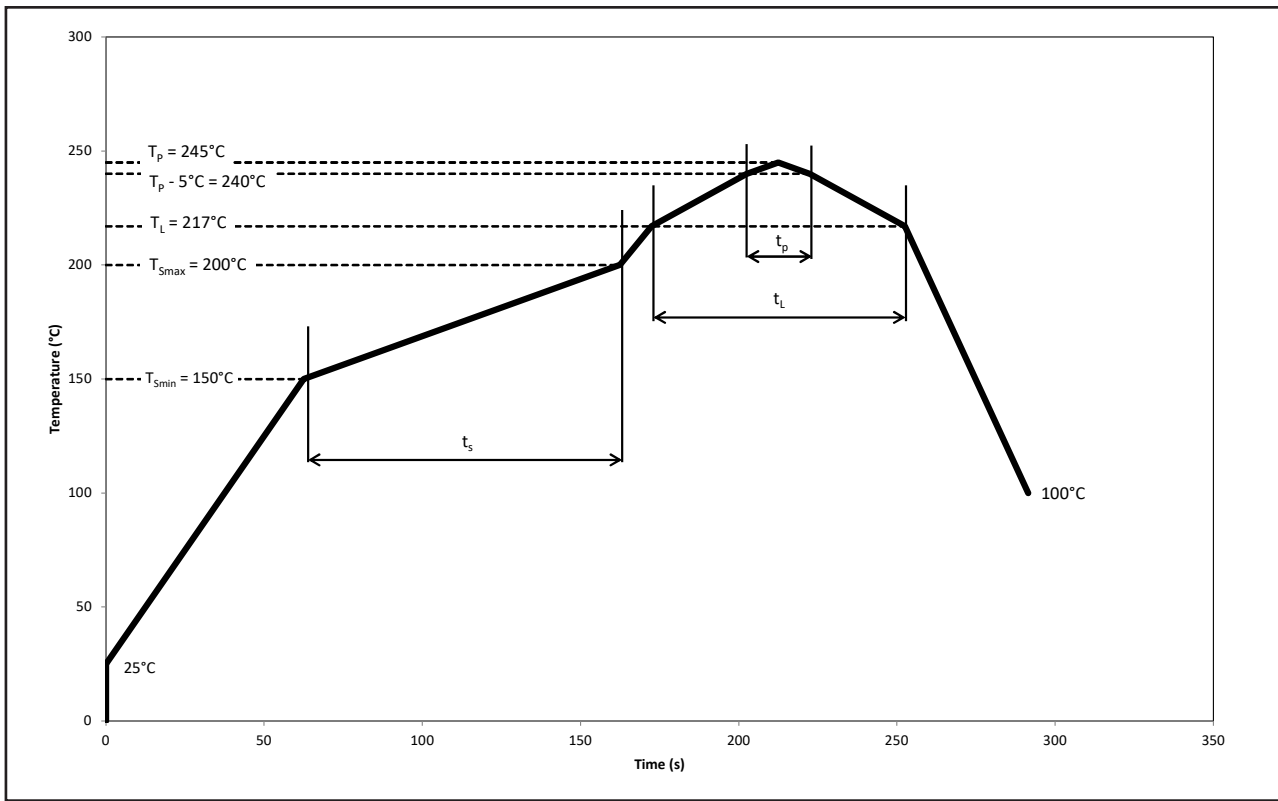

Profile Feature	Symbol	Pb-Free Assembly			Unit
		Min.	Recommended	Max.	
Ramp-up rate to preheat 25°C to $T_{smin}$	-	-	2	3	°C/s
Time $t_s$ $T_{smin}$ to $T_{smax}$	$t_s$	60	100	120	s
Ramp-up rate to peak $T_L$ to $T_p$	-	-	2	3	°C/s
Liquidous temperature	$T_L$	-	217	-	°C
Time above liquidous temperature	$t_L$	60	80	150	s
Peak temperature	$T_p$	-	245	260	°C
Time within 5°C of the specified peak temperature $T_p - 5^\circ\text{C}$	$t_p$	10	20	30	s
Ramp-down rate $T_p$ to 100°C	-	-	3	6	°C/s
Time 25°C to $T_p$	-	-	-	480	s

## Appendix

### 1) **Brightness:**

- 1.1 Luminous intensity is measured at current pulse 25 ms(typ) with an internal reproducibility of  $\pm 8 \%$  and an expanded uncertainty of  $\pm 11 \%$  (according to GUM with a coverage factor of  $k=3$ ).
- 1.2 Luminous flux is measured at current pulse 25 ms(typ) with an internal reproducibility of  $\pm 8 \%$  and an expanded uncertainty of  $\pm 11 \%$  (according to GUM with a coverage factor of  $k=3$ ).
- 1.3 Radiant intensity is measured at current pulse 25 ms(typ) with an internal reproducibility of  $\pm 8 \%$  and an expanded uncertainty of  $\pm 11 \%$  (according to GUM with a coverage factor of  $k=3$ ).
- 1.4 Radiant flux is measured at current pulse 25 ms(typ) with an internal reproducibility of  $\pm 8 \%$  and an expanded uncertainty of  $\pm 11 \%$  (according to GUM with a coverage factor of  $k=3$ ).

### 2) **Color:**

- 2.1 Chromaticity coordinate groups are measured at current pulse 25 ms(typ) with an internal reproducibility of  $\pm 0.005$  and an expanded uncertainty of  $\pm 0.01$  (accordingly to GUM with a coverage factor of  $k=3$ ).
- 2.2 Dominant wavelength is measured at current pulse 25 ms(typ) with an internal reproducibility of  $\pm 0.5\text{nm}$  and an expanded uncertainty of  $\pm 1\text{nm}$  (accordingly to GUM with a coverage factor of  $k=3$ ).

### 3) **Voltage:**

- 3.1 Forward Voltage,  $V_f$  is measured when a current pulse of 8 ms(typ) with an internal reproducibility of  $\pm 0.05\text{V}$  and an expanded uncertainty of  $\pm 0.1\text{V}$  (accordingly to GUM with a coverage factor of  $k=3$ ).

### 4) **Typical Values:**

- 4.1 Due to the specific conditions of semiconductor devices' manufacturing processes, the provided typical data and calculated correlations of technical parameters should only be considered as statistical values. It is important to note that the actual parameters of individual devices may deviate from these typical data, calculated correlations or the typical characteristic line. Dominant reserves the right to update this typical data without prior notice, particularly in response to technical enhancements.

### 5) **Tolerance of Measure**

- 5.1 In the drawing, normally the tolerances used are at  $\pm 0.1$  with the dimension measurement unit in mm.

**Revision History**

<b>Page</b>	<b>Subjects</b>	<b>Date of Modification</b>
8	Typo Error on Package Outline	29 May 2019
2, 6, 7	Update Absolute Maximum Ratings Update Graph	28 Nov 2019
4	Update OEM Spec	10 Jan 2020
11, 12, 13	Update Packaging Specification Update Recommended Pb-free Soldering Profile	11 Mar 2022
2, 3, 6, 7	Add New Partno: MCAZY-VZHG-PQ3+PQ3-2+1 & MCAZY-VZHG-NQ2+PQ3-4+1 Add Amber Wavelength Update Graph: Relative Luminous Flux Vs Forward Current, Forward Current Vs Forward Voltage, Relative Spectral Emission, Forward Voltage Vs Junction Temperature, Relative Luminous Flux Vs Junction Temperature, Wavelength Vs Junction Temperature	09 Sep 2022
2	Not for New Design: MCSZY-VZHG-LM3+PQ3-3+1, MCSZY-VZHG-L3N+PQ3-2+1, MCAZY-VZHG-PQ3+PQ3-2+1, MCAZY-VZHG-NQ2+PQ3-4+1 Add New Part No: MCSZY-VZHG-LM3+P3R2-3+1, MCSZY-VZHG-L3N+P3R2-2+1, MCAZY-VZHG-PQ3+P3R2-2+1, MCAZY-VZHG-NQ2+P3R2-4+1	04 Aug 2023
11, 12	Update Quantity per Reel: 1000pcs to 1500pcs	14 Nov 2023
12	Update Packaging Specification	21 Feb 2025

**NOTE**

All the information contained in this document is considered to be reliable at the time of publishing. However, DOMINANT Opto Technologies does not assume any liability arising out of the application or use of any product described herein.

DOMINANT Opto Technologies reserves the right to make changes to any products in order to improve reliability, function or design.

DOMINANT Opto Technologies products are not authorized for use as critical components in life support devices or systems without the express written approval from the Managing Director of DOMINANT Opto Technologies.

Dispose of product is in accordance with local, regional, national and international regulations.

## About Us

DOMINANT Opto Technologies is a dynamic company that is amongst the world's leading automotive LED manufacturers. With an extensive industry experience and relentless pursuit of innovation, DOMINANT's state-of-art manufacturing and development capabilities have become a trusted and reliable brand across the globe. More information about DOMINANT Opto Technologies, an IATF 16949 and ISO 14001 certified company, can be found under <http://www.dominant-semi.com>.

**Please contact us for more information:**

DOMINANT Opto Technologies Sdn. Bhd.  
Lot 6, Batu Berendam, FTZ Phase III, 75350 Melaka, Malaysia  
Tel: (606) 283 3566 Fax: (606) 283 0566  
E-mail: [sales@dominant-semi.com](mailto:sales@dominant-semi.com)

---