

### Mini DomiLED

Synonymous with function and performance, the Mini DomiLED series is perfectly suited for a variety of cross-industrial applications due to its small package outline, durability and superior brightness.



### Features:

- > High brightness surface mount LED.
- > Based on InGaN technology.
- > 120° viewing angle.
- > Small package outline (LxWxH) of 2.0 x 1.4 x 1.3mm.
- > Qualified according to JEDEC moisture sensitivity Level 2.
- > Compatible to IR reflow soldering.
- > Environmental friendly; RoHS compliance.
- > Compliance to automotive standard; AEC-Q102.
- > Passed Corrosion Resistant Test. *Appx. 4.1*



### Applications:

- > Automotive: Interior applications, eg: switches, climate control system, dashboard, etc.



**Optical characteristics at Tj=25°C**

Part Ordering Number	Color	Viewing Angle°	Luminous Intensity @ 10mA IV (mcd) <i>Appx. 1.1</i>		
			Min.	Typ.	Max.
DNT-DJS-VW2-1-I1	True Green, 525nm	120	715.0	1125.0	1800.0
● DNT-DJS-T2U-1-I1	True Green, 525nm	120	355.0	550.0	715.0
DNB-DJS-RS1-1-I1	Blue, 470nm	120	112.5	170.0	224.0
DNB-DJS-ST1-1-I1	Blue, 470nm	120	180.0	285.0	355.0
● DNB-DJS-Q2R-1-I1	Blue, 470nm	120	90.0	120.0	180.0
● Not for new design					

**Electrical Characteristics at Tj=25°C**

Part Number	Vf @ If = 10mA <i>Appx. 3.1</i>			Vr @ Ir = 10 µA
	Min. (V)	Typ. (V)	Max. (V)	Min. (V)
DNx-DJS	2.8	3.1	3.6	5.0

**Absolute Maximum Ratings**

	Maximum Value	Unit
DC Forward Current	20	mA
Peak Pulse Current; (Ts = 55°C, tp = 100µs, D = 0.03)	120	mA
Reverse Voltage <i>Appx. 6.1</i>	5	V
ESD Threshold (HBM)	2000	V
LED Junction Temperature	125	°C
Operating Temperature	-40 ... +105	°C
Storage Temperature	-40 ... +110	°C
Power Dissipation (at room temperature)	80	mW
Thermal resistance (Rated current = 10mA, Ts = 25 °C)		
- Junction / ambient, R <sub>th JA</sub>	480	K/W
- Junction / solder point, R <sub>th JS</sub>	230	K/W
(Mounting on FR4 PCB, pad size >= 16 mm <sup>2</sup> per pad)		

### Wavelength Grouping at Tj=25°C

Color	Group	Wavelength distribution (nm) <i>Appx. 2.2</i>
DNT; True Green	Full	520 - 535
	A	520 - 525
	B	525 - 530
	C	530 - 535
DNB; Blue	Full	465 - 475
	A	465 - 470
	B	470 - 475

InGaN wavelength is very sensitive to drive current. Operating at lower current is not recommended and may yield unpredictable performance. Current pulsing should be used for dimming purposes.

### Luminous Intensity Group at Tj=25°C

Brightness Group	Luminous Intensity <i>Appx. 1.1</i> IV (mcd)
Q2	90.0 ... 112.5
R1	112.5 ... 140.0
R2	140.0 ... 180.0
S1	180.0 ... 224.0
S2	224.0 ... 285.0
T1	285.0 ... 355.0
T2	355.0 ... 450.0
U1	450.0 ... 560.0
U2	560.0 ... 715.0
V1	715.0 ... 900.0
V2	900.0 ... 1125.0
W1	1125.0 ... 1400.0
W2	1400.0 ... 1800.0

### Vf Bining (Optional)

Vf @ If = 10mA	Forward Voltage (V) <i>Appx. 3.1</i>
VM6	2.70 ... 3.00
VM7	3.00 ... 3.30
VM8	3.30 ... 3.60

Please consult sales and marketing to incorporate special part number to incorporate Vf binning.

**Relative Luminous Intensity Vs Forward Current**

$I_v/I_v(10\text{mA}) = f(I_F); T_j = 25^\circ\text{C}$

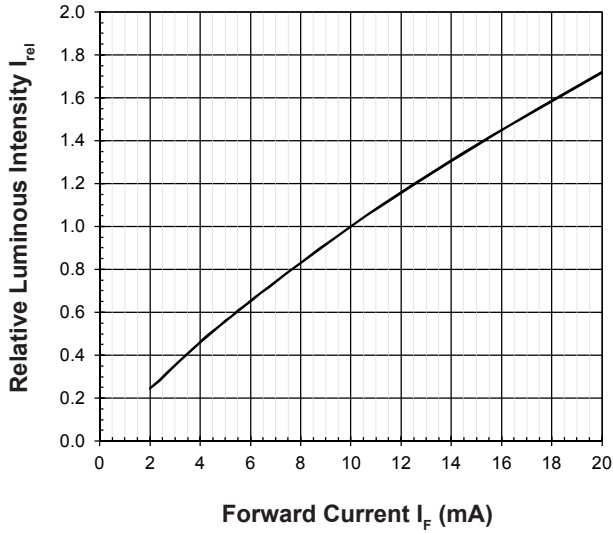

**Forward Current Vs Forward Voltage**

$I_F = f(V_F); T_j = 25^\circ\text{C}$

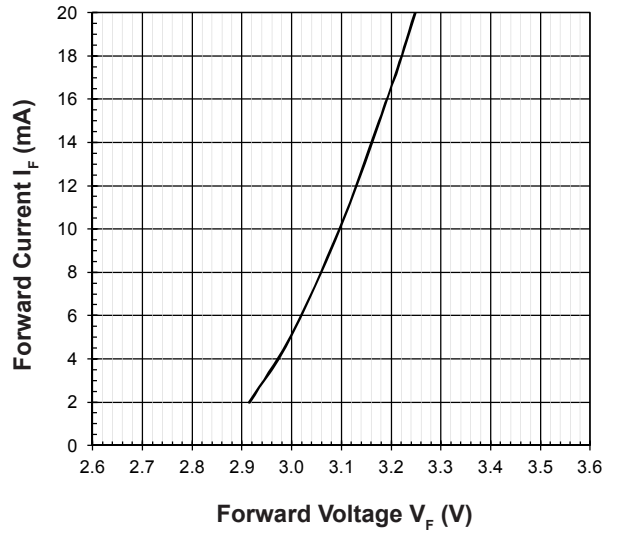

**Maximum Current Vs Temperature**

$I_F = f(T)$

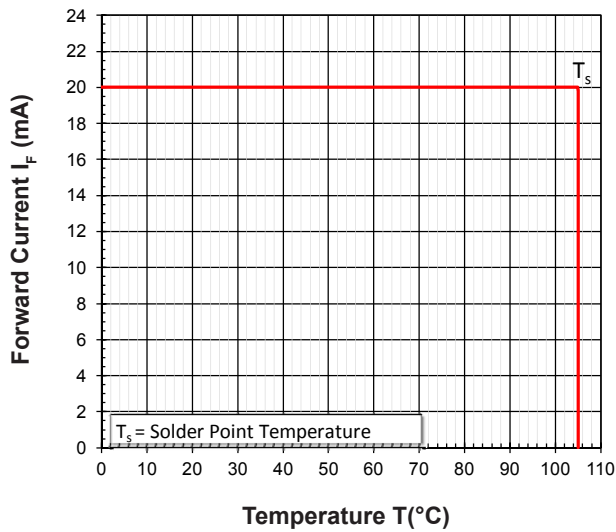

**Relative Spectral Emission**

$I_{rel} = f(\lambda); T_j = 25^\circ\text{C}; I_F = 10\text{mA}$

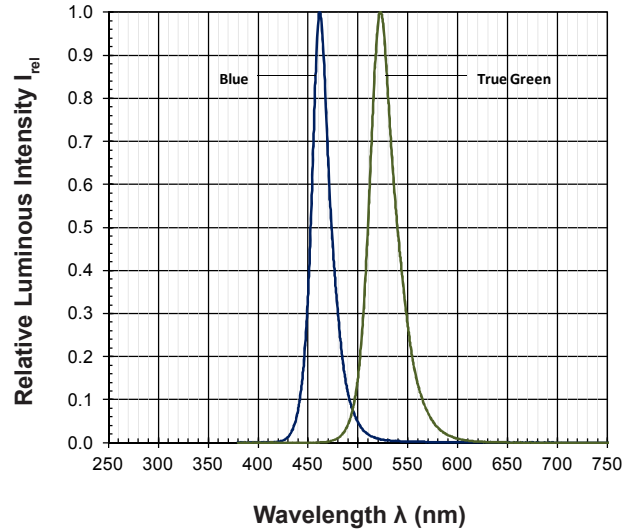

**Allowable Forward Current Vs Duty Ratio**

$(T_s = 55^\circ\text{C}; t_p \leq 100\mu\text{s})$



**Radiation Pattern**

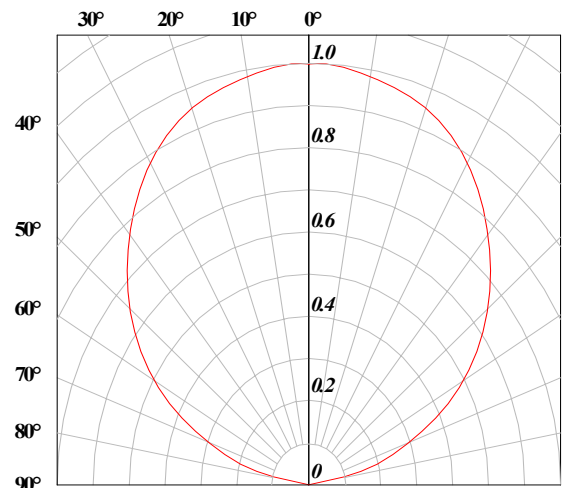

**Relative Wavelength Shift Vs Forward Current**

$\lambda_{dom} = f(I_F); T_j = 25^\circ\text{C}$

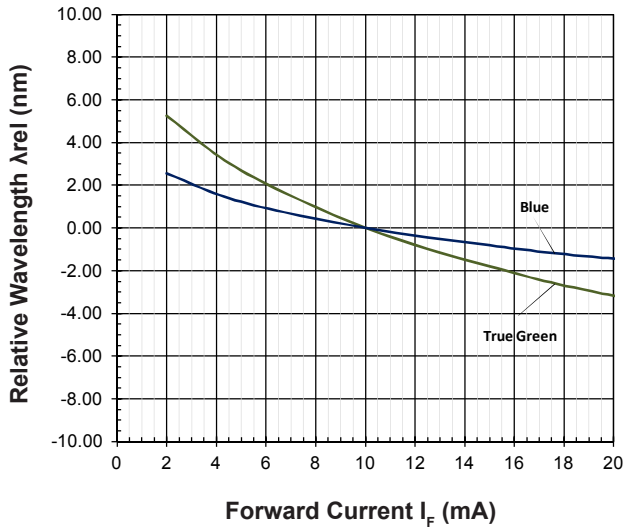

**Relative Forward Voltage Vs Junction Temperature**

$\Delta V_F = V_F - V_F(25^\circ\text{C}) = f(T_j); I_F = 10\text{mA}$

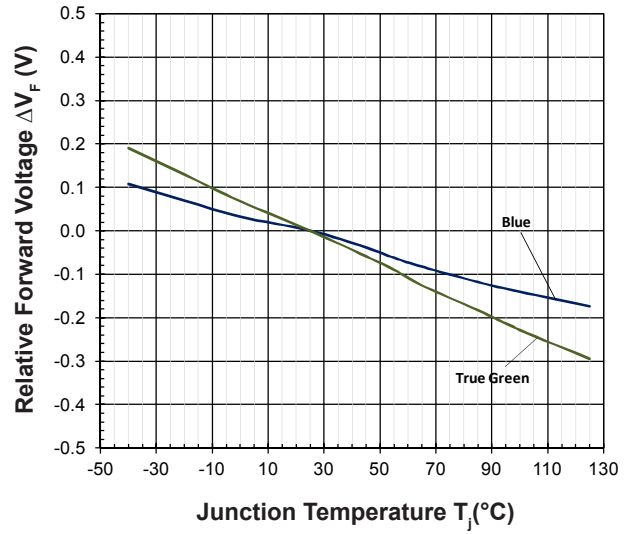

**Relative Luminous Intensity Vs Junction Temperature**

$I_V/I_V(25^\circ\text{C}) = f(T_j); I_F = 10\text{mA}$

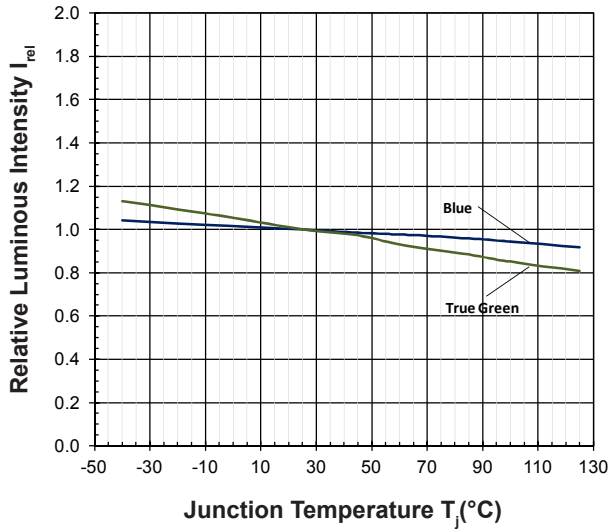

**Relative Wavelength Vs Junction Temperature**

$\Delta\lambda_{dom} = \lambda_{dom} - \lambda_{dom}(25^\circ\text{C}) = f(T_j); I_F = 10\text{mA}$

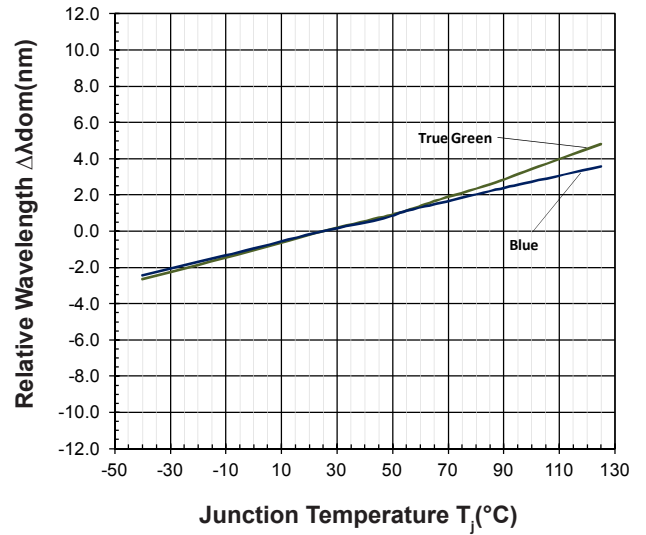

**Mini DomiLED • InGaN : DNx-DJS-XXX-1-I1 Package Outlines**

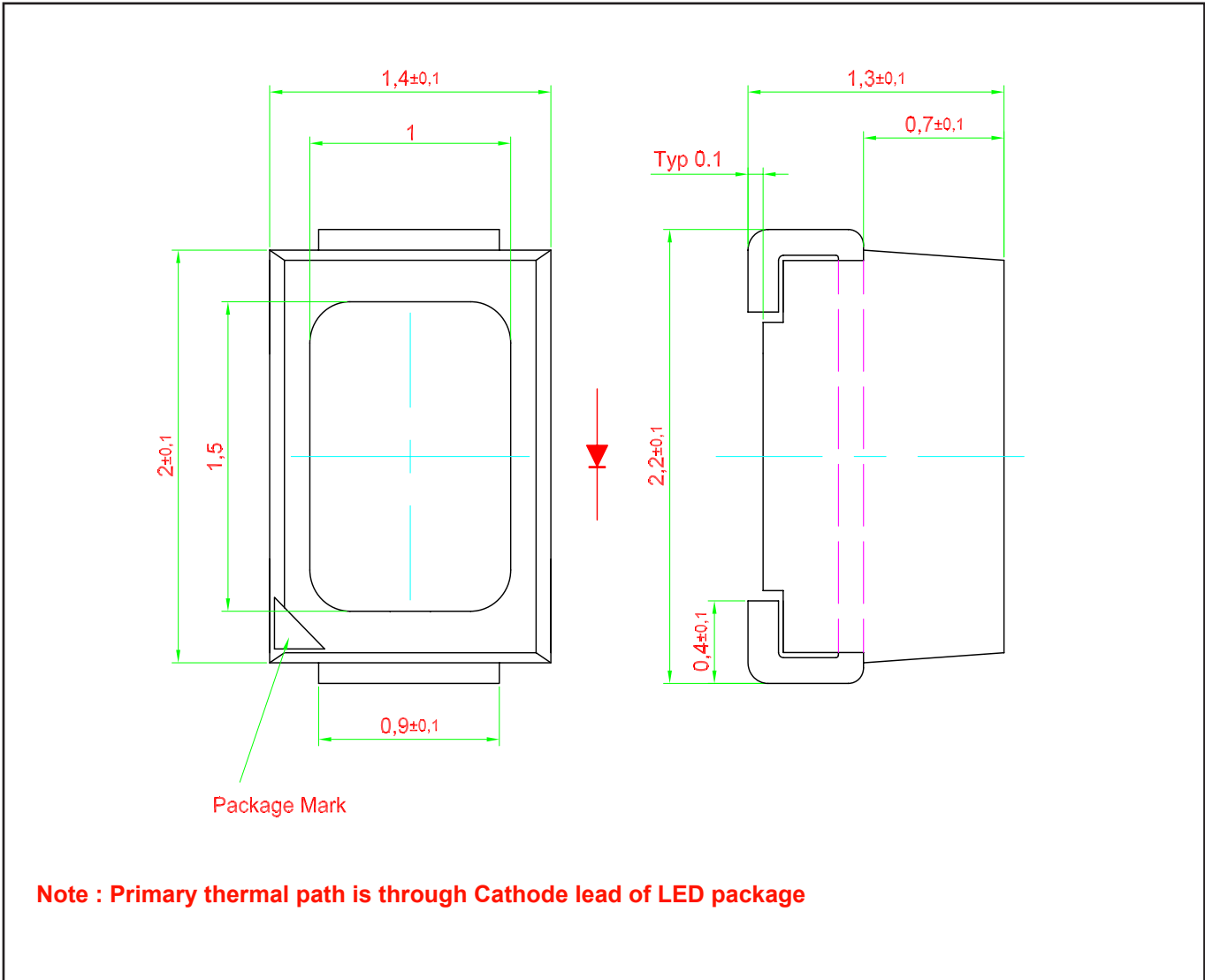

**Material**

	Material
Lead-frame	Cu Alloy With Ag Plating
Package	High Temperature Resistant Plastic, PPA
Encapsulant	Silicone Resin
Soldering Leads	Sn-Sn Plating

### Recommended Solder Pad

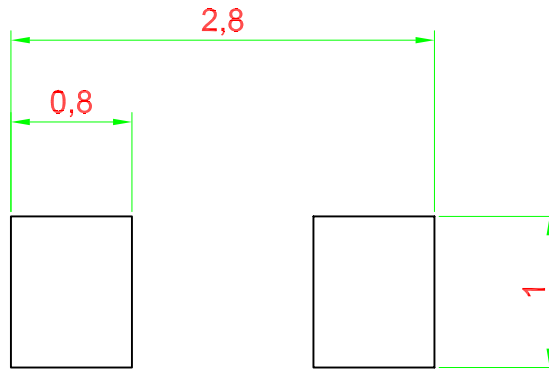

### Improved Design For Better Heat Dissipation

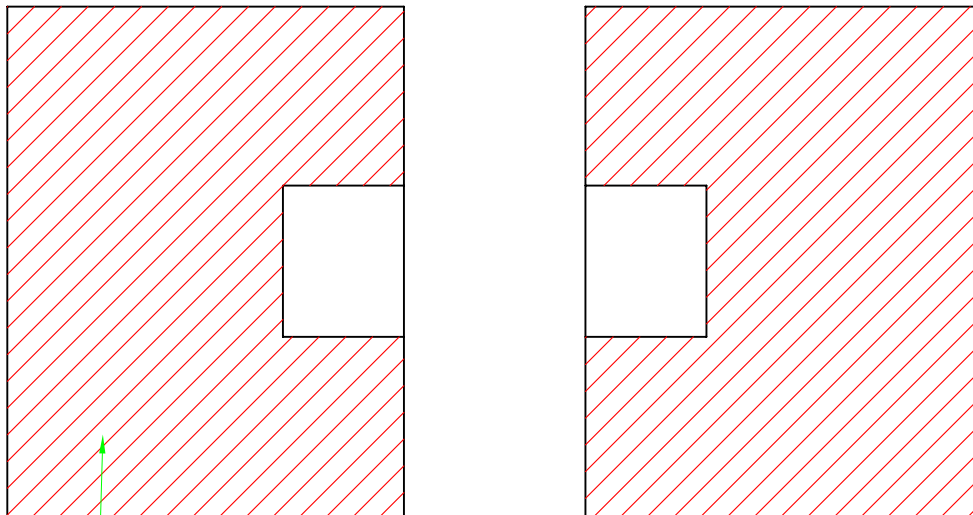

Additional Cu area for improved heat dissipation, > 16mm sq.

 Solder resist.

### Taping and orientation

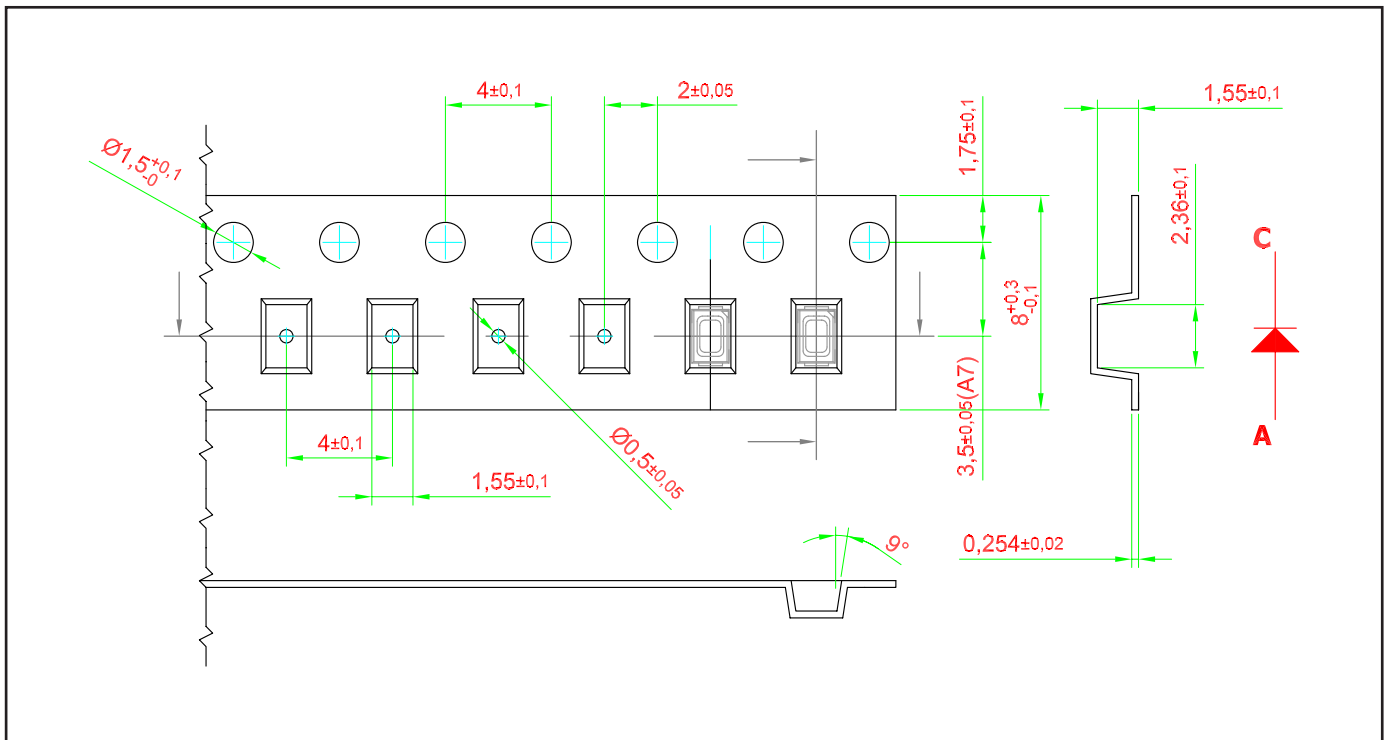



**Packaging Specification**

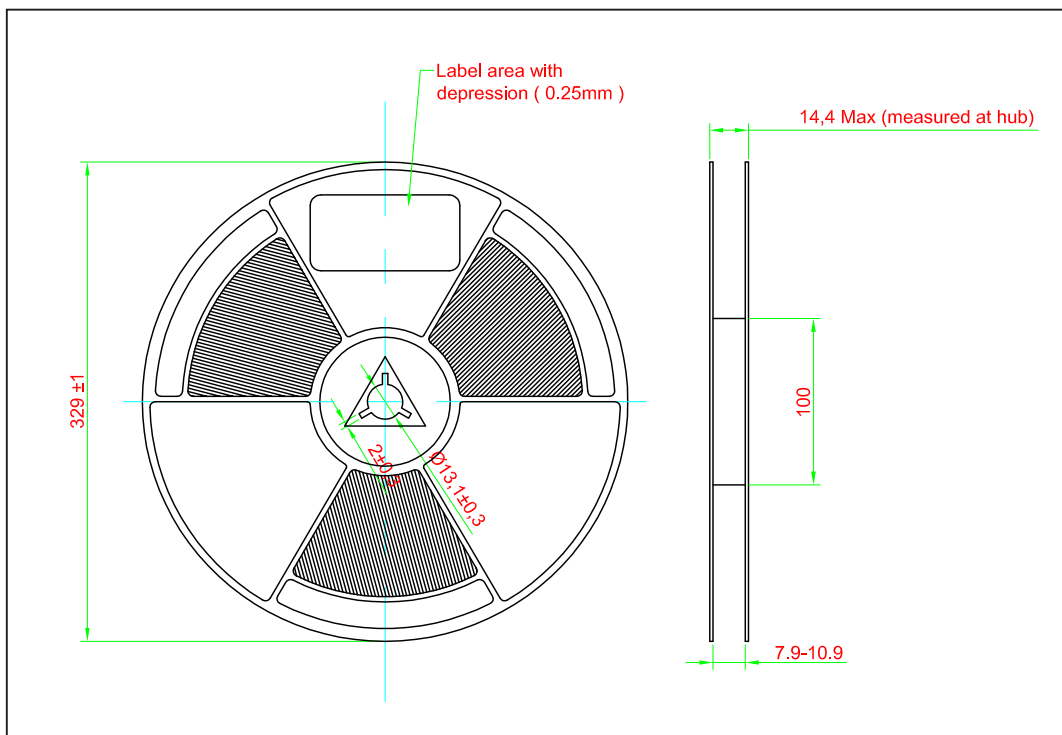
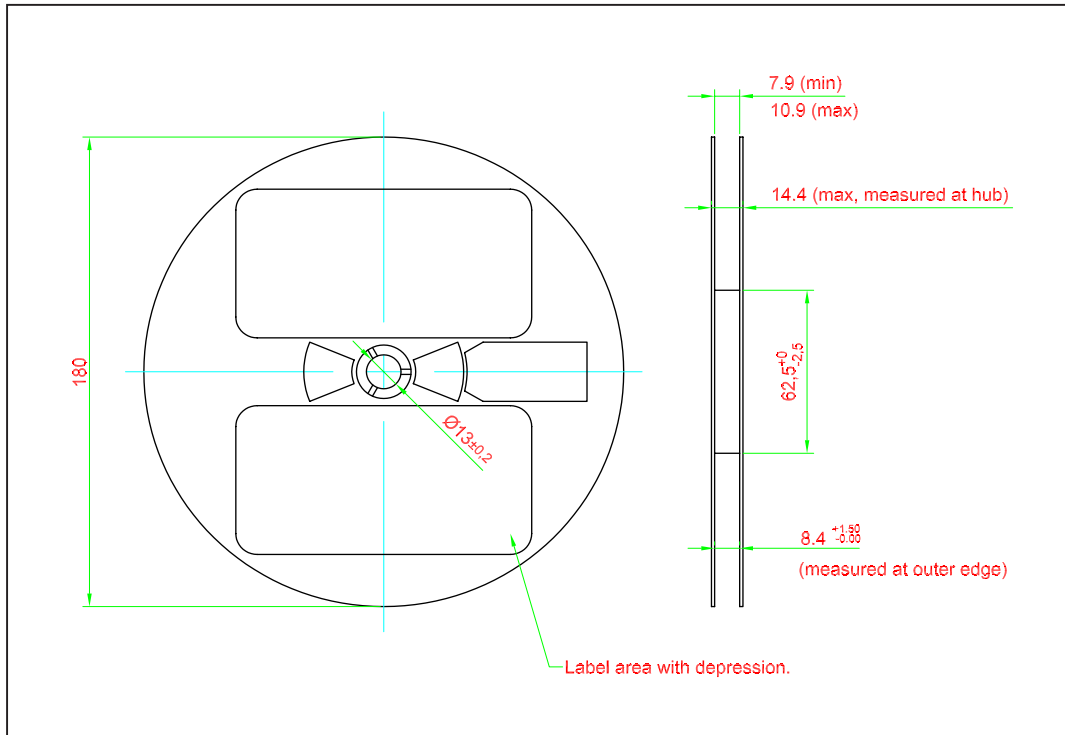

	Reel Diameter (mm)	Quantity (pcs)	Partno
Standard Packing	180	3000	DNx-DJS-xxx-x-I1
Optional Packing	329	10000	DNx-DJS-xxx-x-I1-J

## Packaging Specification

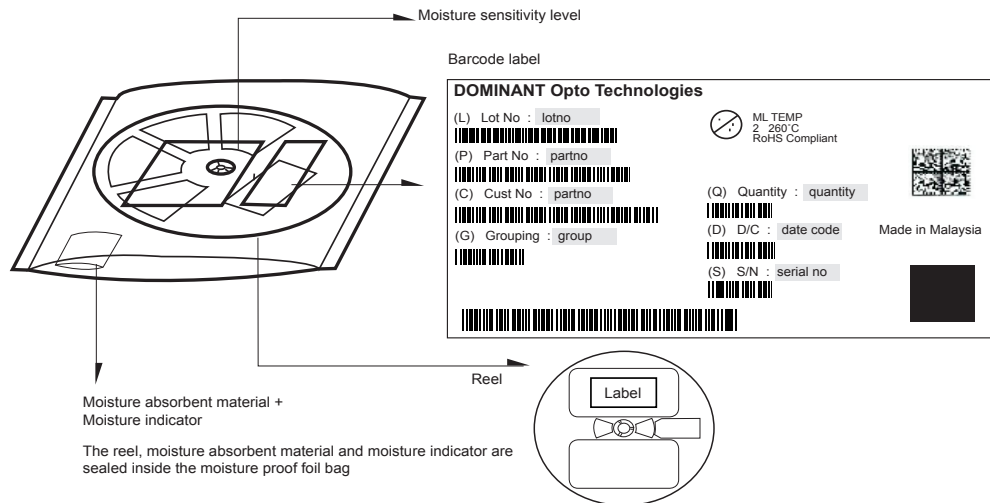

Quantity per bag (pcs)	Average 1pc Mini DomiLED (gram)	1 completed bag (gram)
3000	0.007	200 ± 10
10000	0.007	550 ± 10

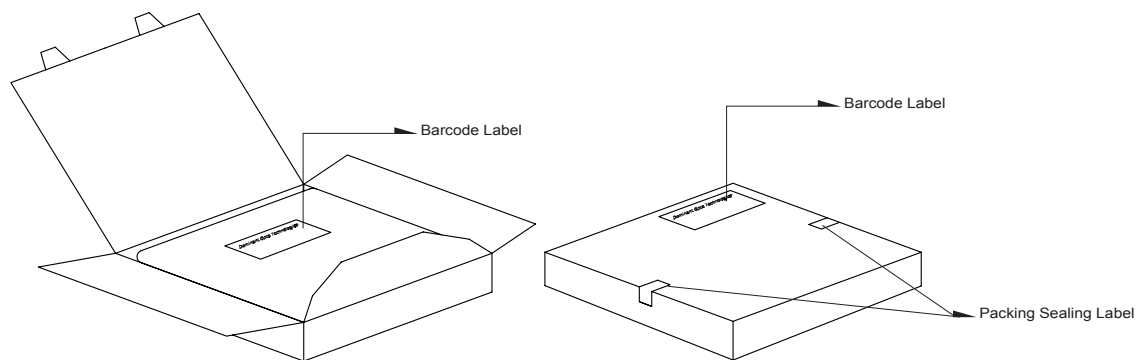

Reel Diameter (mm)	Packing Box Dimensions (mm)
180	210 x 210 x 16
329	345 x 345 x 16

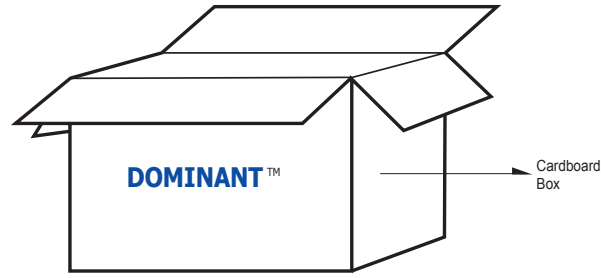

Reel Diameter (mm)	Cardboard Box Size	Dimensions (mm)	Empty Box Weight (kg)	Reel / Box
180	Super Small	325 x 225 x 190	0.38	9 reels MAX
180	Small	325 x 225 x 280	0.54	15 reels MAX
180	Medium	570 x 440 x 230	1.46	60 reels MAX
180	Large	570 x 440 x 460	1.92	120 reels MAX
329	Medium	373 x 373 x 285	1.02	13 reels MAX
329	Large	580 x 373 x 405	1.50	30 reels MAX

## Recommended Pb-free Soldering Profile

Product complies to MSL Level 2 acc. to JEDEC

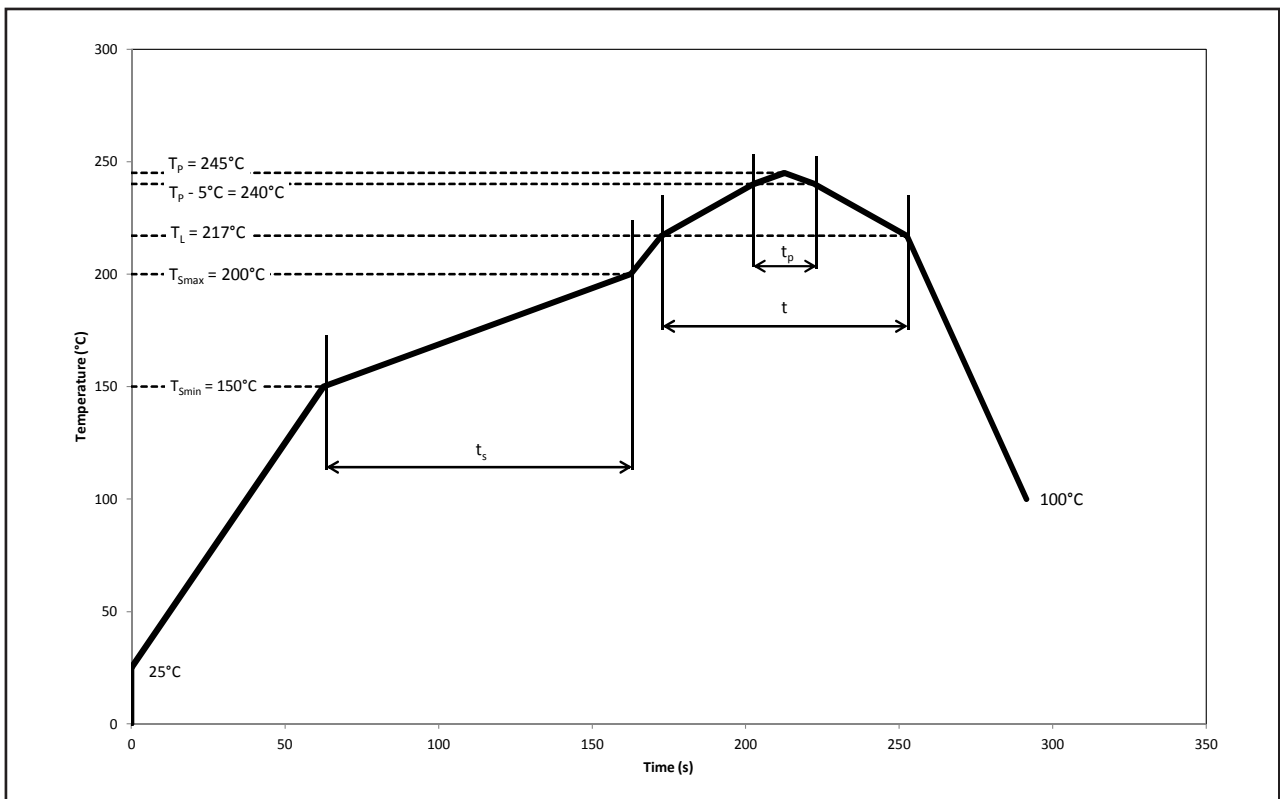

Profile Feature	Symbol	Pb-Free Assembly			Unit
		Min.	Recommended	Max.	
Ramp-up rate to preheat 25°C to $T_{smin}$	-	-	2	3	°C/s
Time $t_s$ $T_{smin}$ to $T_{smax}$	$t_s$	60	100	120	s
Ramp-up rate to peak $T_L$ to $T_p$	-	-	2	3	°C/s
Liquidous temperature	$T_L$	-	217	-	°C
Time above liquidous temperature	t	60	80	150	s
Peak temperature	$T_p$	-	245	260	°C
Time within 5°C of the specified peak temperature $T_p - 5^\circ\text{C}$	$T_p$	10	20	30	s
Ramp-down rate $T_p$ to 100°C	-	-	3	6	°C/s
Time 25°C to $T_p$	-	-	-	480	s

## Appendix

### 1) **Brightness:**

- 1.1 Luminous intensity is measured at current pulse 25 ms(typ) with an internal reproducibility of  $\pm 8\%$  and an expanded uncertainty of  $\pm 11\%$  (according to GUM with a coverage factor of  $k=3$ ).
- 1.2 Luminous flux is measured at current pulse 25 ms(typ) with an internal reproducibility of  $\pm 8\%$  and an expanded uncertainty of  $\pm 11\%$  (according to GUM with a coverage factor of  $k=3$ ).
- 1.3 Radiant intensity is measured at current pulse 25 ms(typ) with an internal reproducibility of  $\pm 8\%$  and an expanded uncertainty of  $\pm 11\%$  (according to GUM with a coverage factor of  $k=3$ ).
- 1.4 Radiant flux is measured at current pulse 25 ms(typ) with an internal reproducibility of  $\pm 8\%$  and an expanded uncertainty of  $\pm 11\%$  (according to GUM with a coverage factor of  $k=3$ ).

### 2) **Color:**

- 2.1 Chromaticity coordinate groups are measured at current pulse 25 ms(typ) with an internal reproducibility of  $\pm 0.005$  and an expanded uncertainty of  $\pm 0.01$  (accordingly to GUM with a coverage factor of  $k=3$ ).
- 2.2 Dominant wavelength is measured at current pulse 25 ms(typ) with an internal reproducibility of  $\pm 0.5\text{nm}$  and an expanded uncertainty of  $\pm 1\text{nm}$  (accordingly to GUM with a coverage factor of  $k=3$ ).

### 3) **Voltage:**

- 3.1 Forward Voltage,  $V_f$  is measured when a current pulse of 8 ms(typ) with an internal reproducibility of  $\pm 0.05\text{V}$  and an expanded uncertainty of  $\pm 0.1\text{V}$  (accordingly to GUM with a coverage factor of  $k=3$ ).

### 4) **Typical Values:**

- 4.1 At special conditions of LED manufacturing processes, typical data or calculated correlations of technical parameters only reflect the statistical figures. But not necessarily correspond to the actual parameters of each single product, which could differ from the typical data or calculated correlations or the typical characteristic line. These typical data may change whenever technical improvements happen.

### 5) **Tolerance of Measure**

- 5.1 Unless otherwise noted in drawing, tolerances are specified with  $\pm 0.1$  and dimension are specific in mm.

### 6) **Reverse Voltage:**

- 6.1 Not designed for reverse operation. Continuous reverse voltage can cause migration and LED damage.

**Revision History**

Page	Subjects	Date of Modification
2	Add Thermal Resistance	06 Mar 2014
1, 4, 9	Update Features Typo Error on Graph: Dominant Wavelength Shift Vs Forward Current Update Packaging Specification	15 Jun 2015
5	Typo Error on Material Add Notes in Packaging Outline	04 Aug 2015
2	Add new partno: DNB-DJS-ST1-1-I1	05 Oct 2015
1, 4, 5, 12	Add Features Update Graph Add Appendix	18 Jul 2017
2, 3, 9, 10, 11, 12	Add Test Condition for Thermal Resistance Add Vf Binning Optional Update Packaging Specification Update Appendix	16 Dec 2019
1, 2, 4, 5, 12	Update Features: AEC-Q101 to AEC-Q102. Update Application Update Peak Pulse Current Update Operating and Storage Temperature Update Graph Update Recommended Pb-free Soldering Profile	20 Nov 2020

**NOTE**

All the information contained in this document is considered to be reliable at the time of publishing. However, DOMINANT Opto Technologies does not assume any liability arising out of the application or use of any product described herein.

DOMINANT Opto Technologies reserves the right to make changes to any products in order to improve reliability, function or design.

DOMINANT Opto Technologies products are not authorized for use as critical components in life support devices or systems without the express written approval from the Managing Director of DOMINANT Opto Technologies.

## About Us

DOMINANT Opto Technologies is a dynamic company that is amongst the world's leading automotive LED manufacturers. With an extensive industry experience and relentless pursuit of innovation, DOMINANT's state-of-art manufacturing and development capabilities have become a trusted and reliable brand across the globe. More information about DOMINANT Opto Technologies, an IATF 16949 and ISO 14001 certified company, can be found under <http://www.dominant-semi.com>.

### **Please contact us for more information:**

DOMINANT Opto Technologies Sdn. Bhd  
Lot 6, Batu Berendam, FTZ Phase III, 75350 Melaka, Malaysia.  
Tel: +606 283 3566 Fax: +606 283 0566  
E-mail: [sales@dominant-semi.com](mailto:sales@dominant-semi.com)

---