

Mini DomiLED

With the intense colors that seem to glow with energy and its significant brightness, Mini DomiLED LED is a highly reliable design device. Its dynamic nature makes it perfect choice for lighting applications, office and home applications and standard industrial applications.



Features:

- > High brightness surface mount LED.
- > Based on InGaN technology.
- > 120° viewing angle.
- > Small package outline (LxWxH) of 2.0 x 1.4 x 1.3mm.
- > Qualified according to JEDEC moisture sensitivity Level 2.
- > Compatible to both IR reflow soldering.
- > Environmental friendly; RoHS compliance.



Applications:

- > Automotive: interior applications, eg: switches, telematics, climate control system, dashboard, etc.



Optical Characteristics at Tj=25°C

Part Ordering Number	Viewing Angle°	Luminous Intensity @ IF = 10mA IV (mcd) <i>Appx. 1.1</i>		
		Min.	Typ.	Max.
DNZB-LJG-U2V-1	120	560.0	900.0	1125.0

Electrical Characteristics at Tj=25°C

Part Number	Vf @ If = 10mA <i>Appx. 3.1</i>			Vr @ Ir = 10 µA <i>Appx. 6.1</i>
	Min. (V)	Typ. (V)	Max. (V)	Min. (V)
DNZB-LJG	2.7	3.0	3.5	5.0

Absolute Maximum Ratings

	Maximum Value	Unit
DC forward current	20	mA
Peak pulse current; (tp ≤ 10µs, Duty cycle = 0.005)	200	mA
Reverse voltage <i>Appx. 6.1</i>	5	V
ESD threshold (HBM)	2000	V
LED junction temperature	125	°C
Operating temperature	-40 ... +100	°C
Storage temperature	-40 ... +100	°C
Power dissipation (at room temperature)	85	mW

DNZB-LJG, Color Grouping *Appx. 2.1*

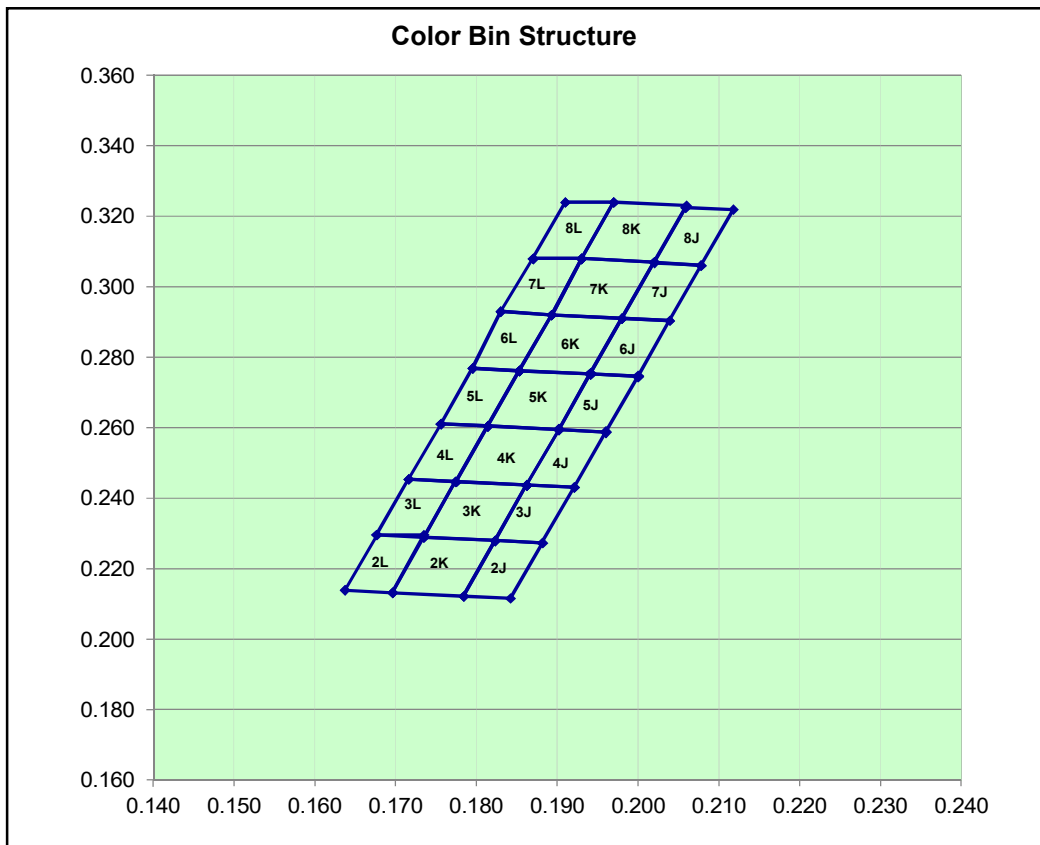

Bin		1	2	3	4
2J	Cx	0.1784	0.1842	0.1882	0.1823
	Cy	0.2122	0.2116	0.2273	0.2280
2K	Cx	0.1696	0.1784	0.1823	0.1735
	Cy	0.2132	0.2122	0.2280	0.2290
2L	Cx	0.1637	0.1696	0.1735	0.1677
	Cy	0.2139	0.2132	0.2296	0.2296
3J	Cx	0.1862	0.1823	0.1881	0.1921
	Cy	0.2437	0.2280	0.2273	0.2431
3K	Cx	0.1774	0.1735	0.1823	0.1862
	Cy	0.2447	0.2289	0.2280	0.2437
3L	Cx	0.1716	0.1676	0.1735	0.1774
	Cy	0.2454	0.2296	0.2289	0.2447
4J	Cx	0.1902	0.1862	0.1921	0.1960
	Cy	0.2595	0.2437	0.2431	0.2588
4K	Cx	0.1814	0.1775	0.1862	0.1902
	Cy	0.2605	0.2447	0.2437	0.2595
4L	Cx	0.1756	0.1716	0.1775	0.1814
	Cy	0.2611	0.2454	0.2447	0.2605
5J	Cx	0.1941	0.1902	0.1960	0.2000
	Cy	0.2753	0.2595	0.2588	0.2746
5K	Cx	0.1853	0.1814	0.1902	0.1941
	Cy	0.2762	0.2605	0.2595	0.2753
5L	Cx	0.1795	0.1756	0.1814	0.1853
	Cy	0.2769	0.2611	0.2605	0.2762

Bin		1	2	3	4
6J	Cx	0.1980	0.1941	0.2000	0.2039
	Cy	0.2910	0.2753	0.2746	0.2904
6K	Cx	0.1893	0.1853	0.1941	0.1980
	Cy	0.2920	0.2762	0.2753	0.2910
6L	Cx	0.1830	0.1795	0.1853	0.1893
	Cy	0.2930	0.2769	0.2762	0.2920
7J	Cx	0.2020	0.1980	0.2039	0.2078
	Cy	0.3070	0.2910	0.2904	0.3060
7K	Cx	0.1930	0.1893	0.1980	0.2020
	Cy	0.3080	0.2920	0.2910	0.3070
7L	Cx	0.1870	0.1830	0.1893	0.1930
	Cy	0.3080	0.2930	0.2920	0.3080
8J	Cx	0.2059	0.2020	0.2078	0.2118
	Cy	0.3225	0.3068	0.3061	0.3219
8K	Cx	0.1970	0.1930	0.2020	0.2060
	Cy	0.3240	0.3080	0.3070	0.3230
8L	Cx	0.1910	0.1870	0.1930	0.1970
	Cy	0.3240	0.3080	0.3080	0.3240

Luminous Intensity Group at Tj=25°C

Brightness Group	Luminous Intensity <small>Appx. 1.1</small> IV (mcd)
U2	560.0 ... 715.0
V1	715.0 ... 900.0
V2	900.0 ... 1125.0

Relative Luminous Intensity Vs Forward Current

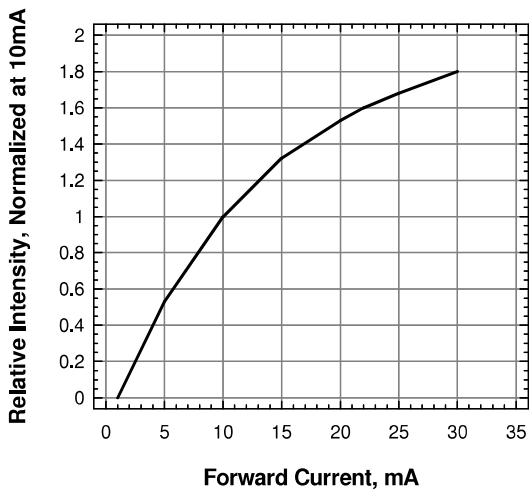

Forward Current Vs Forward Voltage

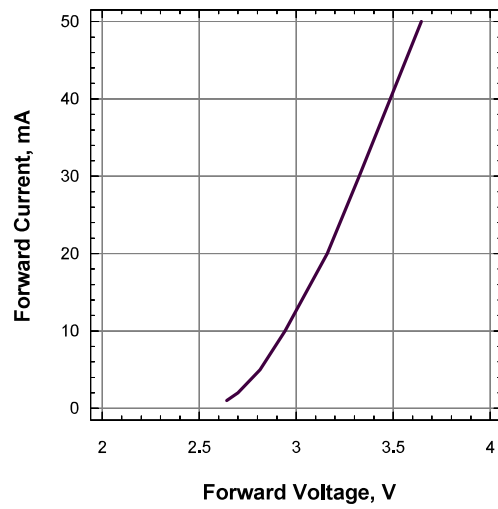

Maximum Current Vs Ambient Temperature

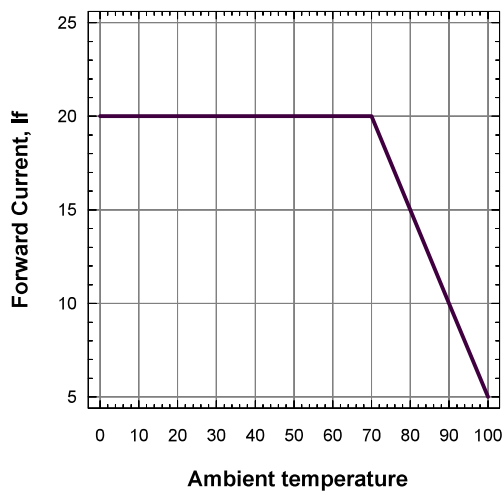

Relative Intensity Vs. Wavelength

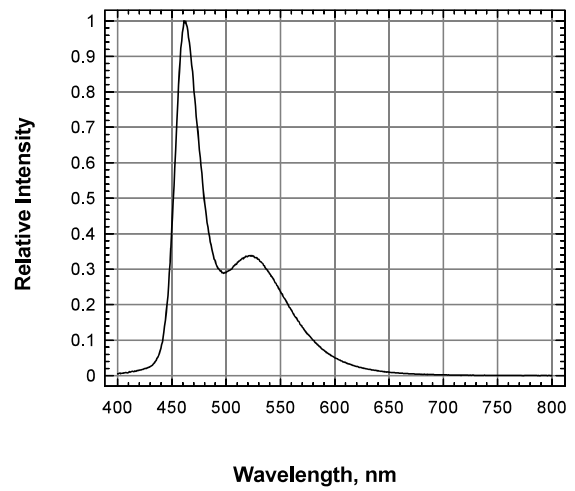

Radiation Pattern

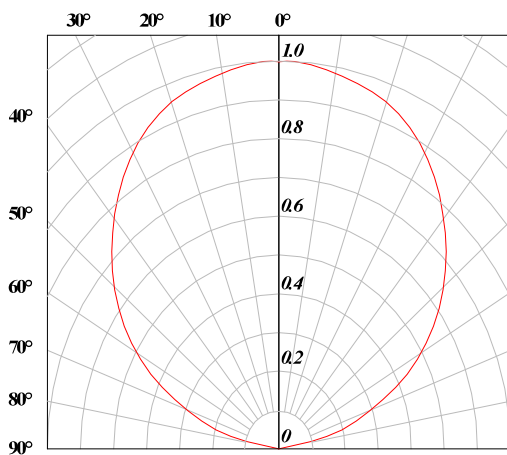

Mini DomiLED • InGaN: DNZB-LJG Package Outlines

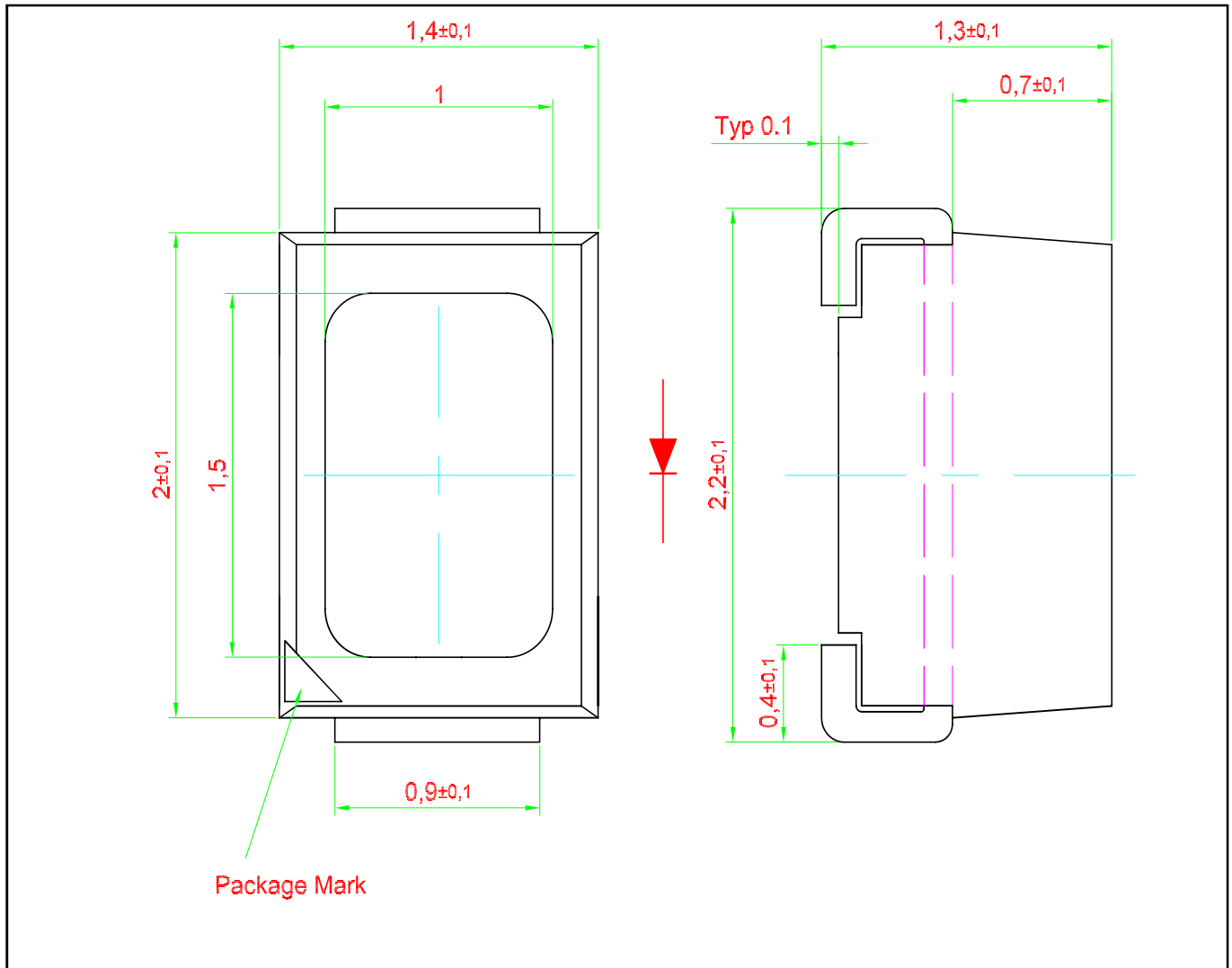

Material

Material	
Lead-frame	Copper Alloy
Package	High Temperature Resistant Plastic, PPA
Encapsulant	Silicone Resin
Soldering Leads	Pure Tin Plating, Sn

Recommended Solder Pad

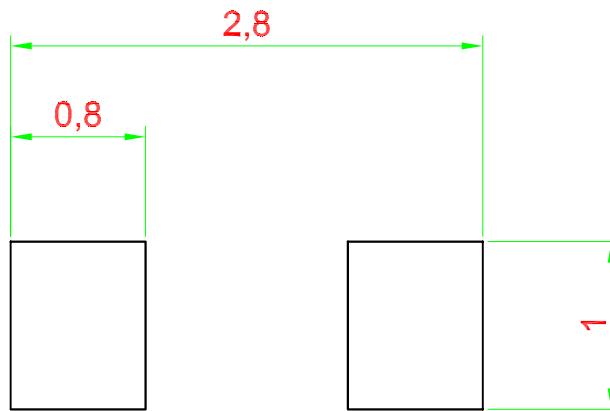

Improved Design For Better Heat Dissipation

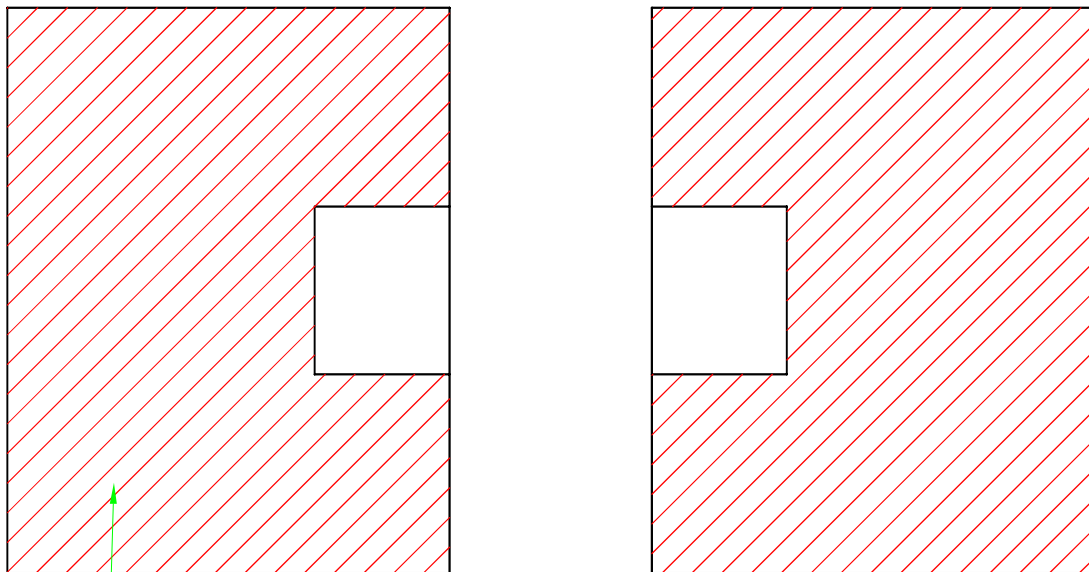

Additional Cu area for improved heat dissipation, > 16mm sq.

 Solder resist.

Taping and orientation

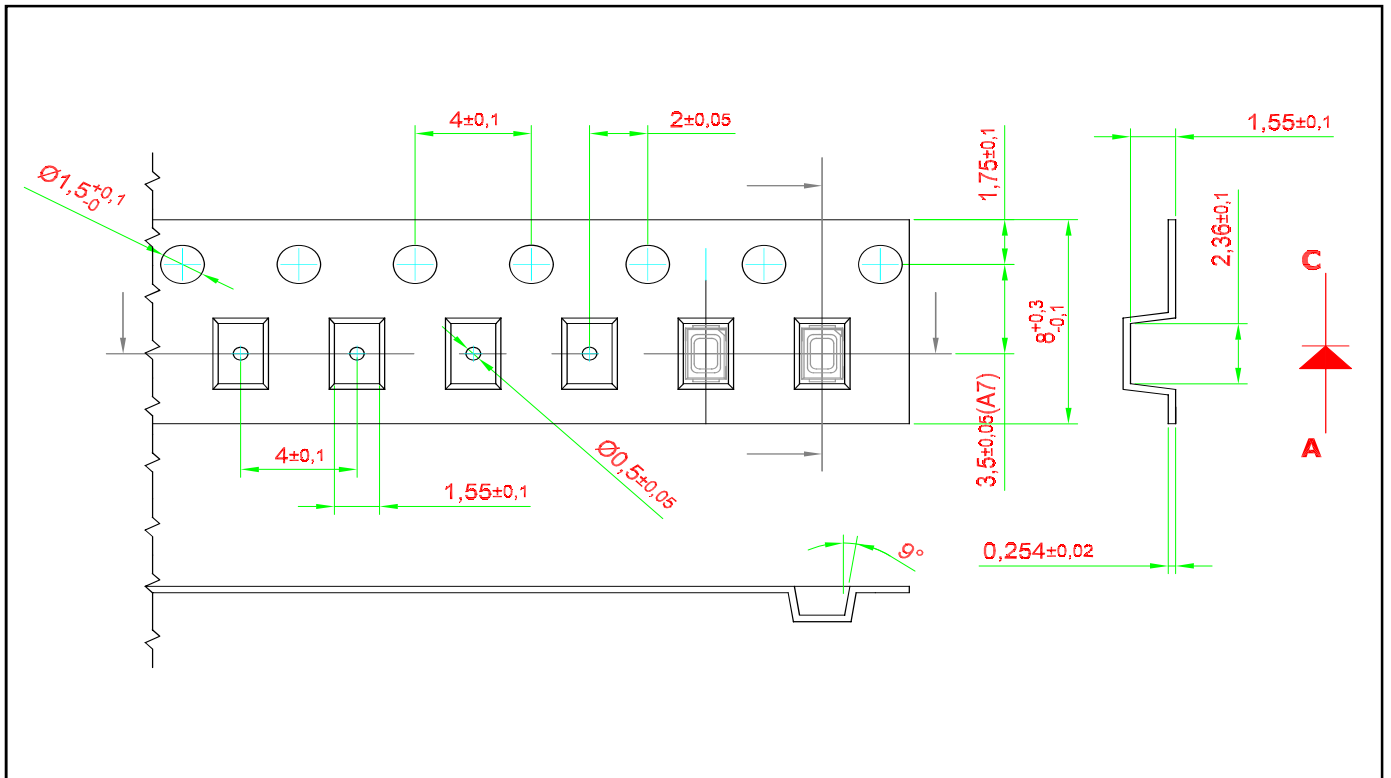

Packaging Specification

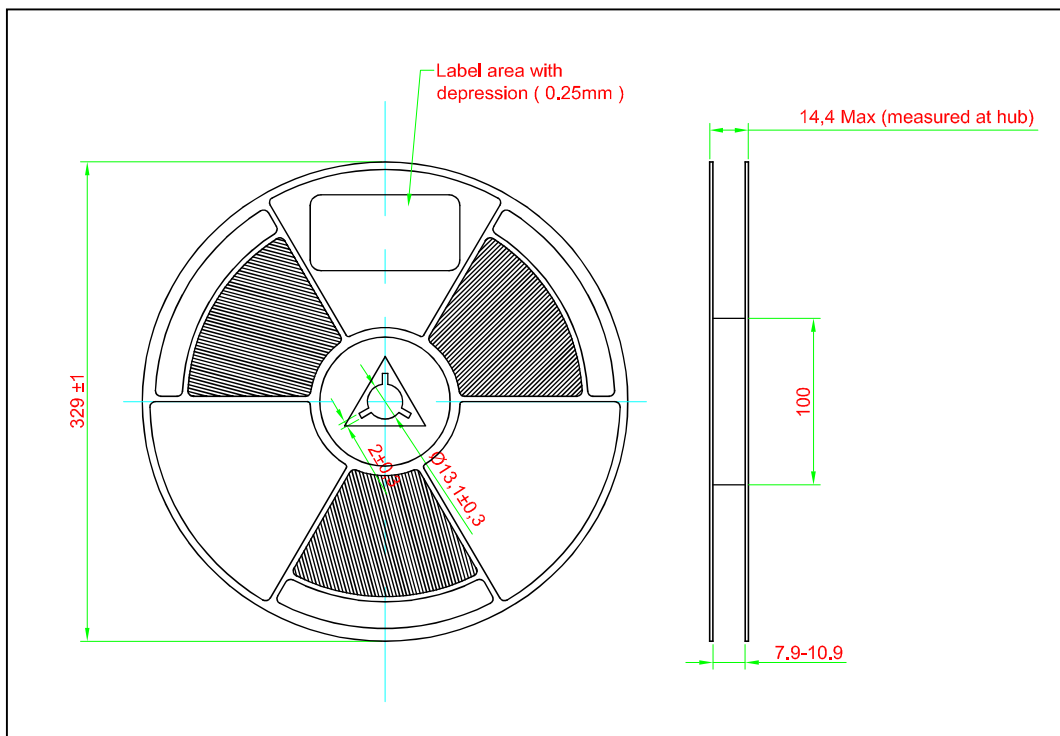
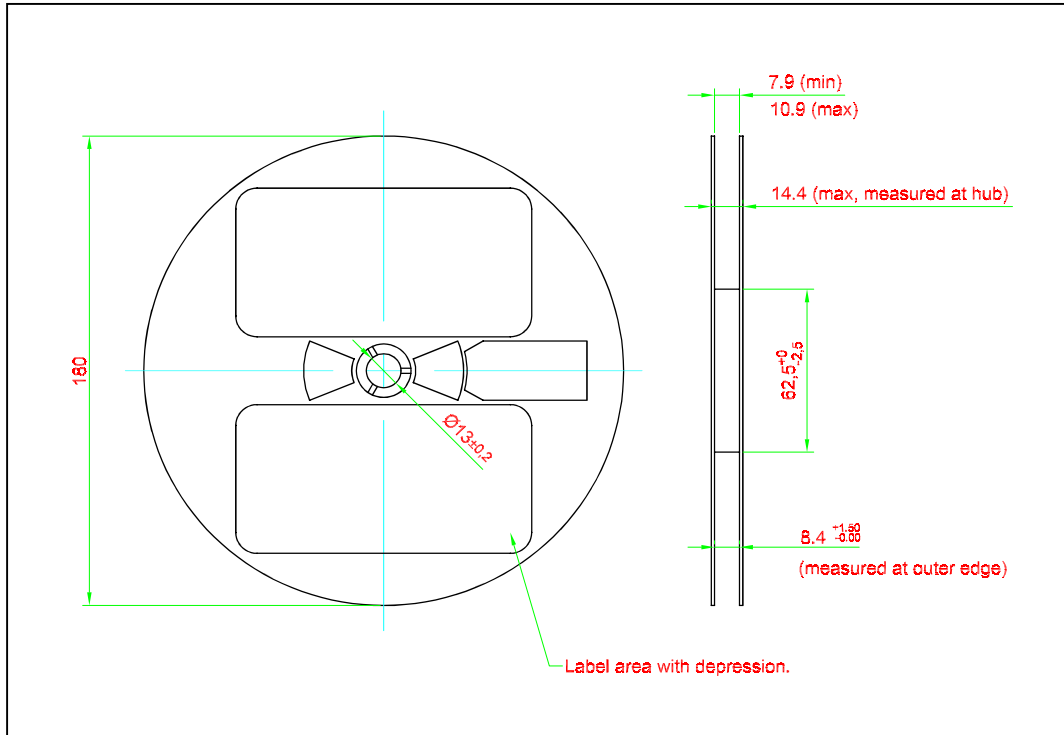

	Reel Diameter (mm)	Quantity (pcs)	Partno
Standard Packing	180	3000	DNZB-LJG-xxx-x
Optional Packing	329	10000	DNZB-LJG-xxx-x-J

Packaging Specification

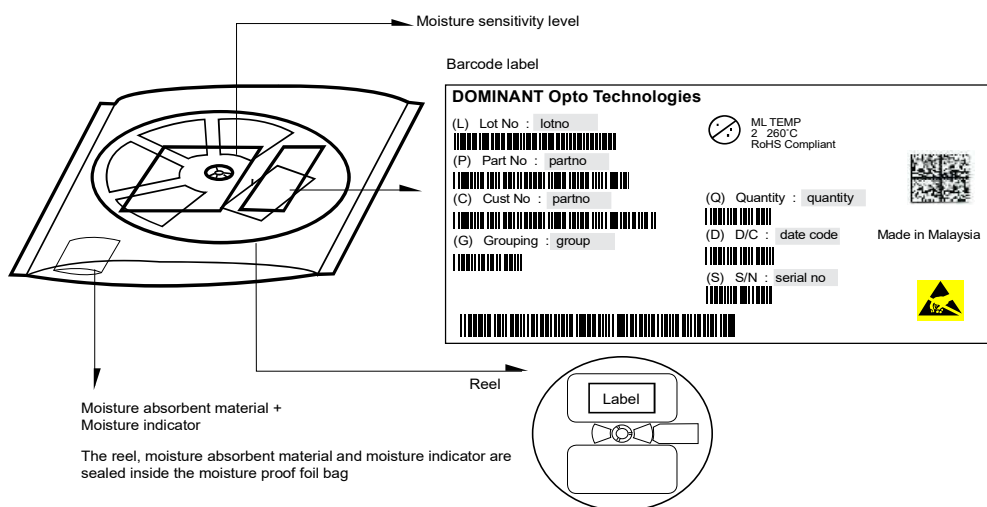

Quantity per bag (pcs)	Average 1pc Mini DomiLED (gram)	1 completed bag (gram)
3000	0.007	200 ± 10
10000	0.007	550 ± 10

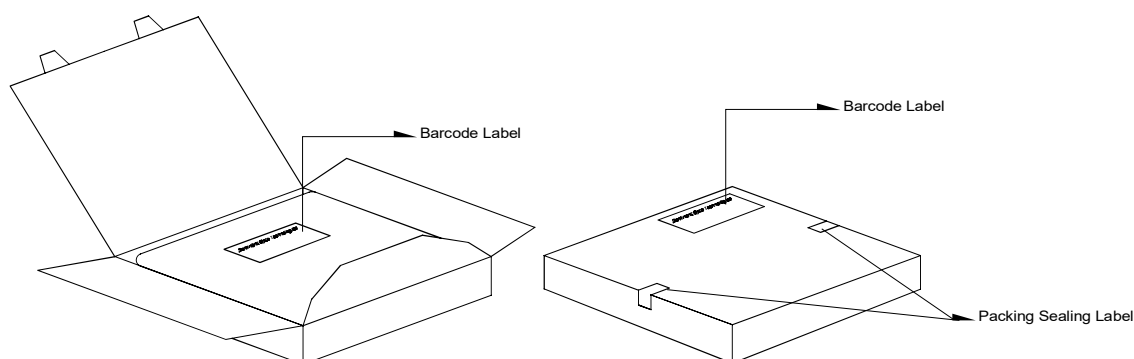

Reel Diameter (mm)	Packing Box Dimensions (mm)
180	210 x 210 x 16
329	345 x 345 x 16

Recommended Pb-free Soldering Profile

Product complies to MSL Level 2 acc. to JEDEC J-STD-020E

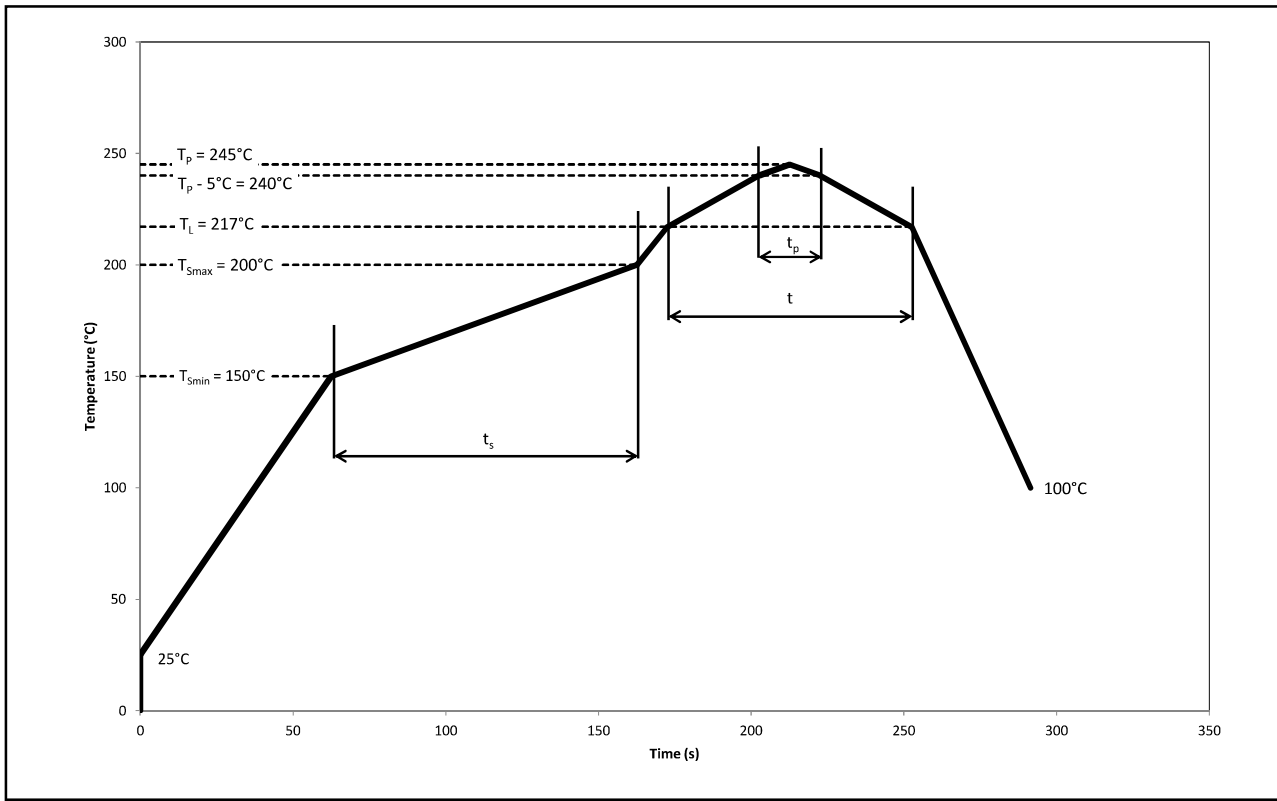

Profile Feature	Symbol	Pb-Free Assembly			Unit
		Min.	Recommended	Max.	
Ramp-up rate to preheat 25°C to T_{smin}	-	-	2	3	°C/s
Time t_s T_{smin} to T_{smax}	t_s	60	100	120	s
Ramp-up rate to peak T_L to T_p	-	-	2	3	°C/s
Liquidous temperature	T_L	-	217	-	°C
Time above liquidous temperature	t	60	80	150	s
Peak temperature	T_p	-	245	260	°C
Time within 5°C of the specified peak temperature $T_p - 5^\circ\text{C}$	T_p	10	20	30	s
Ramp-down rate T_p to 100°C	-	-	3	6	°C/s
Time 25°C to T_p	-	-	-	480	s

Appendix

1) **Brightness:**

- 1.1 Luminous intensity is measured at current pulse 25 ms(typ) with an internal reproducibility of $\pm 8\%$ and an expanded uncertainty of $\pm 11\%$ (according to GUM with a coverage factor of $k=3$).
- 1.2 Luminous flux is measured at current pulse 25 ms(typ) with an internal reproducibility of $\pm 8\%$ and an expanded uncertainty of $\pm 11\%$ (according to GUM with a coverage factor of $k=3$).
- 1.3 Radiant intensity is measured at current pulse 25 ms(typ) with an internal reproducibility of $\pm 8\%$ and an expanded uncertainty of $\pm 11\%$ (according to GUM with a coverage factor of $k=3$).
- 1.4 Radiant flux is measured at current pulse 25 ms(typ) with an internal reproducibility of $\pm 8\%$ and an expanded uncertainty of $\pm 11\%$ (according to GUM with a coverage factor of $k=3$).

2) **Color:**

- 2.1 Chromaticity coordinate groups are measured at current pulse 25 ms(typ) with an internal reproducibility of ± 0.005 and an expanded uncertainty of ± 0.01 (accordingly to GUM with a coverage factor of $k=3$).
- 2.2 Dominant wavelength is measured at current pulse 25 ms(typ) with an internal reproducibility of $\pm 0.5\text{nm}$ and an expanded uncertainty of $\pm 1\text{nm}$ (accordingly to GUM with a coverage factor of $k=3$).

3) **Voltage:**

- 3.1 Forward Voltage, V_f is measured when a current pulse of 8 ms(typ) with an internal reproducibility of $\pm 0.05\text{V}$ and an expanded uncertainty of $\pm 0.1\text{V}$ (accordingly to GUM with a coverage factor of $k=3$).

4) **Typical Values:**

- 4.1 At special conditions of LED manufacturing processes, typical data or calculated correlations of technical parameters only reflect the statistical figures. But not necessarily correspond to the actual parameters of each single product, which could differ from the typical data or calculated correlations or the typical characteristic line. These typical data may change whenever technical improvements happen.

5) **Tolerance of Measure**

- 5.1 Unless otherwise noted in drawing, tolerances are specified with ± 0.1 and dimension are specific in mm.

6) **Reverse Voltage:**

- 6.1 Not designed for reverse operation. Continuous reverse voltage can cause migration and LED damage.

Revision History

Page	Subjects	Date of Modification
-	Initial Release	25 Jul 2013
3	Update Color Bin Structure	11 Mar 2014
10, 11, 12, 13	Update Package Specification Update Recommended Pb-free Soldering Profile Add Appendix	02 Sep 2021

NOTE

All the information contained in this document is considered to be reliable at the time of publishing. However, DOMINANT Opto Technologies does not assume any liability arising out of the application or use of any product described herein.

DOMINANT Opto Technologies reserves the right to make changes to any products in order to improve reliability, function or design.

DOMINANT Opto Technologies products are not authorized for use as critical components in life support devices or systems without the express written approval from the Managing Director of DOMINANT Opto Technologies.

About Us

DOMINANT Opto Technologies is a dynamic company that is amongst the world's leading automotive LED manufacturers. With an extensive industry experience and relentless pursuit of innovation, DOMINANT's state-of-art manufacturing and development capabilities have become a trusted and reliable brand across the globe. More information about DOMINANT Opto Technologies, an IATF 16949 and ISO 14001 certified company, can be found under <http://www.dominant-semi.com>.

Please contact us for more information:

DOMINANT Opto Technologies Sdn. Bhd
Lot 6, Batu Berendam, FTZ Phase III, 75350 Melaka, Malaysia.
Tel: +606 283 3566 Fax: +606 283 0566
E-mail: sales@dominant-semi.com
