

Mini DomiLED

With the intense colors that seem to glow with energy and its significant brightness, Mini DomiLED white LED is a highly reliable design device. Its dynamic nature makes it perfect choice for lighthing applications, office and home applications and standard industrial applications.



Features:

- > High brightness surface mount LED.
- > Based on InGaN technology.
- > 120° viewing angle.
- > Small package outline (LxWxH) of 2.0 x 1.4 x 1.3mm.
- > Qualified according to JEDEC moisture sensitivity Level 2.
- > Compatible to both IR reflow soldering.
- > Environmental friendly; RoHS compliance.
- > Compliance to automotive standard; AEC-Q101.
- > Passed Corrosion Resistant Test. *Appx 7.1*

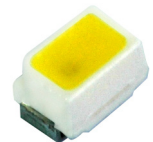

Applications:

- > Automotive: interior applications, eg: switches, telematics, climate control system, dashboard, etc.
- > Communication: indicator and backlight in mobilephone.
- > Display: full color display video notice board.
- > Industry: white goods (eg: Oven, microwave, etc.).



Optical Characteristics at Tj=25°C

Part Ordering Number	Color	Viewing Angle°	Luminous Intensity @ IF = 5mA IV (mcd) <i>Appx. 1.1</i>		
			Min.	Typ.	Max.
DNF-DJG-RS2-1-I5	Warm White	120	112.5	180.0	285.0

Notes:

1. High color rendering index (CRI). Minimum CRI of 80.

Electrical Characteristics at Tj=25°C

Part Number	Vf @ If = 5mA <i>Appx. 3.1</i>			Vr @ Ir = 10 µA <i>Appx. 6.1</i>
	Min. (V)	Typ. (V)	Max. (V)	Min. (V)
DNF-DJG	2.6	2.9	3.2	5.0

Absolute Maximum Ratings

	Maximum Value	Unit
DC forward current	20	mA
Peak pulse current; (tp ≤ 10µs, Duty cycle = 0.005)	100	mA
Reverse voltage <i>Appx. 6.1</i>	5	V
ESD threshold (HBM)	2000	V
LED junction temperature	110	°C
Operating temperature	-40 ... +100	°C
Storage temperature	-40 ... +100	°C
Power dissipation (at room temperature)	70	mW
Thermal resistance		
- Junction / ambient, Rth JA	530	K/W
- Junction / solder point, Rth JS	280	K/W
(Mounting on FR4 PCB, pad size ≥ 5 mm ² per pad)		

DNF, Color Grouping *Appx. 2.1*

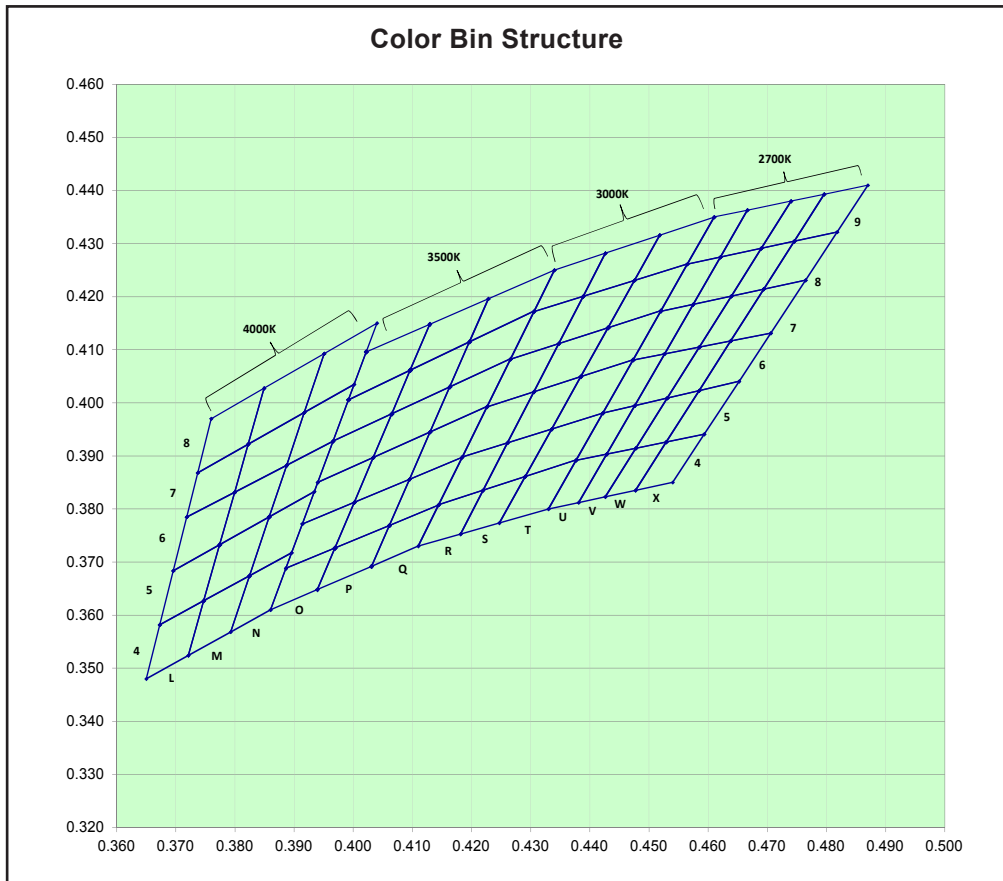

Bin		1	2	3	4
4U	Cx	0.4330	0.4370	0.4430	0.4380
	Cy	0.3800	0.3890	0.3910	0.3810
5U	Cx	0.4370	0.4420	0.4480	0.4430
	Cy	0.3890	0.3980	0.4000	0.3910
6U	Cx	0.4420	0.4470	0.4530	0.4480
	Cy	0.3980	0.4080	0.4090	0.4000
7U	Cx	0.4470	0.4510	0.4580	0.4530
	Cy	0.4080	0.4170	0.4180	0.4090
8U	Cx	0.4510	0.4560	0.4620	0.4580
	Cy	0.4170	0.4260	0.4270	0.4180
9U	Cx	0.4560	0.4610	0.4670	0.4620
	Cy	0.4260	0.4350	0.4370	0.4270
4V	Cx	0.4380	0.4430	0.4480	0.4430
	Cy	0.3810	0.3910	0.3920	0.3830
5V	Cx	0.4430	0.4480	0.4530	0.4480
	Cy	0.3910	0.4000	0.4010	0.3920
6V	Cx	0.4480	0.4530	0.4590	0.4530
	Cy	0.4000	0.4090	0.4100	0.4010
7V	Cx	0.4530	0.4580	0.4640	0.4590
	Cy	0.4090	0.4180	0.4200	0.4100
8V	Cx	0.4580	0.4620	0.4690	0.4640
	Cy	0.4180	0.4270	0.4290	0.4200
9V	Cx	0.4620	0.4670	0.4740	0.4690
	Cy	0.4270	0.4370	0.4380	0.4290

Bin		1	2	3	4
4W	Cx	0.4430	0.4480	0.4540	0.4480
	Cy	0.3830	0.3920	0.3930	0.3840
5W	Cx	0.4480	0.4530	0.4590	0.4540
	Cy	0.3920	0.4010	0.4020	0.3930
6W	Cx	0.4530	0.4590	0.4640	0.4590
	Cy	0.4010	0.4100	0.4120	0.4020
7W	Cx	0.4590	0.4640	0.4700	0.4640
	Cy	0.4100	0.4200	0.4210	0.4120
8W	Cx	0.4640	0.4690	0.4750	0.4700
	Cy	0.4200	0.4290	0.4300	0.4210
9W	Cx	0.4690	0.4740	0.4800	0.4750
	Cy	0.4290	0.4380	0.4400	0.4300
4X	Cx	0.4480	0.4540	0.4590	0.4540
	Cy	0.3840	0.3930	0.3940	0.3850
5X	Cx	0.4540	0.4590	0.4650	0.4590
	Cy	0.3930	0.4020	0.4040	0.3940
6X	Cx	0.4590	0.4640	0.4700	0.4650
	Cy	0.4020	0.4120	0.4130	0.4040
7X	Cx	0.4640	0.4700	0.4760	0.4700
	Cy	0.4120	0.4210	0.4230	0.4130
8X	Cx	0.4700	0.4750	0.4810	0.4760
	Cy	0.4210	0.4300	0.4320	0.4230
9X	Cx	0.4750	0.4800	0.4870	0.4810
	Cy	0.4300	0.4400	0.4410	0.4320
4R	Cx	0.4110	0.4150	0.4220	0.4180
	Cy	0.3730	0.3810	0.3840	0.3750
5R	Cx	0.4150	0.4190	0.4260	0.4220
	Cy	0.3810	0.3900	0.3930	0.3840
6R	Cx	0.4190	0.4220	0.4300	0.4260
	Cy	0.3900	0.3990	0.4020	0.3930
7R	Cx	0.4220	0.4260	0.4350	0.4300
	Cy	0.3990	0.4080	0.4110	0.4020
8R	Cx	0.4260	0.4300	0.4390	0.4350
	Cy	0.4080	0.4170	0.4200	0.4110
9R	Cx	0.4300	0.4340	0.4430	0.4390
	Cy	0.4170	0.4250	0.4290	0.4200
4S	Cx	0.4180	0.4220	0.4300	0.4250
	Cy	0.3750	0.3840	0.3870	0.3780
5S	Cx	0.4220	0.4260	0.4340	0.4300
	Cy	0.3840	0.3930	0.3960	0.3870
6S	Cx	0.4260	0.4300	0.4390	0.4340
	Cy	0.3930	0.4020	0.4050	0.3960
7S	Cx	0.4300	0.4350	0.4430	0.4390
	Cy	0.4020	0.4110	0.4140	0.4050
8S	Cx	0.4350	0.4390	0.4470	0.4430
	Cy	0.4110	0.4200	0.4230	0.4140
9S	Cx	0.4390	0.4430	0.4520	0.4470
	Cy	0.4200	0.4290	0.4320	0.4230
4T	Cx	0.4250	0.4300	0.4370	0.4330
	Cy	0.3780	0.3870	0.3890	0.3800

Bin		1	2	3	4
5T	Cx	0.4300	0.4340	0.4420	0.4370
	Cy	0.3870	0.3960	0.3980	0.3890
6T	Cx	0.4340	0.4390	0.4470	0.4420
	Cy	0.3960	0.4050	0.4080	0.3980
7T	Cx	0.4390	0.4430	0.4510	0.4470
	Cy	0.4050	0.4140	0.4170	0.4080
8T	Cx	0.4430	0.4470	0.4560	0.4510
	Cy	0.4140	0.4230	0.4260	0.4170
9T	Cx	0.4470	0.4520	0.4610	0.4560
	Cy	0.4230	0.4320	0.4350	0.4260
4O	Cx	0.3860	0.3890	0.3980	0.3940
	Cy	0.3610	0.3690	0.3730	0.3650
5O	Cx	0.3890	0.3910	0.4010	0.3980
	Cy	0.3690	0.3770	0.3810	0.3730
6O	Cx	0.3910	0.3940	0.4040	0.4010
	Cy	0.3770	0.3850	0.3900	0.3810
7O	Cx	0.3940	0.3970	0.4070	0.4040
	Cy	0.3850	0.3930	0.3980	0.3900
8O	Cx	0.3970	0.4000	0.4100	0.4070
	Cy	0.3930	0.4010	0.4060	0.3980
9O	Cx	0.4000	0.4030	0.4130	0.4100
	Cy	0.4010	0.4100	0.4150	0.4060
4P	Cx	0.3940	0.3980	0.4060	0.4030
	Cy	0.3650	0.3730	0.3770	0.3690
5P	Cx	0.3980	0.4010	0.4100	0.4060
	Cy	0.3730	0.3810	0.3860	0.3770
6P	Cx	0.4010	0.4040	0.4130	0.4100
	Cy	0.3810	0.3900	0.3940	0.3860
7P	Cx	0.4040	0.4070	0.4160	0.4130
	Cy	0.3900	0.3980	0.4030	0.3940
8P	Cx	0.4070	0.4100	0.4200	0.4160
	Cy	0.3980	0.4060	0.4120	0.4030
9P	Cx	0.4100	0.4130	0.4230	0.4200
	Cy	0.4060	0.4150	0.4200	0.4120
4Q	Cx	0.4030	0.4060	0.4150	0.4110
	Cy	0.3690	0.3770	0.3810	0.3730
5Q	Cx	0.4060	0.4100	0.4190	0.4150
	Cy	0.3770	0.3860	0.3900	0.3810
6Q	Cx	0.4100	0.4130	0.4220	0.4190
	Cy	0.3860	0.3940	0.3990	0.3900
7Q	Cx	0.4130	0.4160	0.4260	0.4220
	Cy	0.3940	0.4030	0.4080	0.3990
8Q	Cx	0.4160	0.4200	0.4300	0.4260
	Cy	0.4030	0.4120	0.4170	0.4080
9Q	Cx	0.4200	0.4230	0.4340	0.4300
	Cy	0.4120	0.4200	0.4250	0.4170
4L	Cx	0.3650	0.3670	0.3750	0.3720
	Cy	0.3480	0.3580	0.3620	0.3520
5L	Cx	0.3670	0.3690	0.3770	0.3750
	Cy	0.3580	0.3680	0.3730	0.3620

Bin		1	2	3	4
6L	Cx	0.3690	0.3710	0.3800	0.3770
	Cy	0.3680	0.3780	0.3830	0.3730
7L	Cx	0.3710	0.3740	0.3830	0.3800
	Cy	0.3780	0.3870	0.3930	0.3830
8L	Cx	0.3740	0.3760	0.3850	0.3830
	Cy	0.3870	0.3970	0.4030	0.3930
4M	Cx	0.3720	0.3750	0.3820	0.3790
	Cy	0.3520	0.3620	0.3670	0.3560
5M	Cx	0.3750	0.3770	0.3850	0.3820
	Cy	0.3620	0.3730	0.3780	0.3670
6M	Cx	0.3770	0.3800	0.3880	0.3850
	Cy	0.3730	0.3830	0.3880	0.3780
7M	Cx	0.3800	0.3830	0.3920	0.3880
	Cy	0.3830	0.3930	0.3990	0.3880
8M	Cx	0.3830	0.3850	0.3950	0.3920
	Cy	0.3930	0.4030	0.4090	0.3990
4N	Cx	0.3790	0.3820	0.3900	0.3860
	Cy	0.3560	0.3670	0.3720	0.3610
5N	Cx	0.3820	0.3850	0.3930	0.3900
	Cy	0.3670	0.3780	0.3830	0.3720
6N	Cx	0.3850	0.3880	0.3970	0.3930
	Cy	0.3780	0.3880	0.3930	0.3830
7N	Cx	0.3880	0.3920	0.4010	0.3970
	Cy	0.3880	0.3990	0.4040	0.3930
8N	Cx	0.3920	0.3950	0.4040	0.4010
	Cy	0.3990	0.4090	0.4150	0.4040

InGaN wavelength is very sensitive to drive current. Operating at lower current is not recommended and may yield unpredictable performance current pulsing should be used for dimming purposed.

Luminous Intensity Group at Tj=25°C

Brightness Group	Luminous Intensity <small>Appx. 1.1</small> IV (mcd)
R1	112.5 ... 140.0
R2	140.0 ... 180.0
S1	180.0 ... 224.0
S2	224.0 .. 285.0

Relative Intensity Vs Forward Current

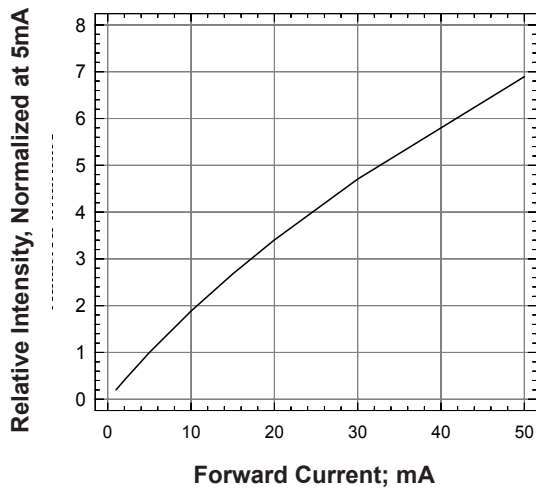

Forward Current Vs Forward Voltage

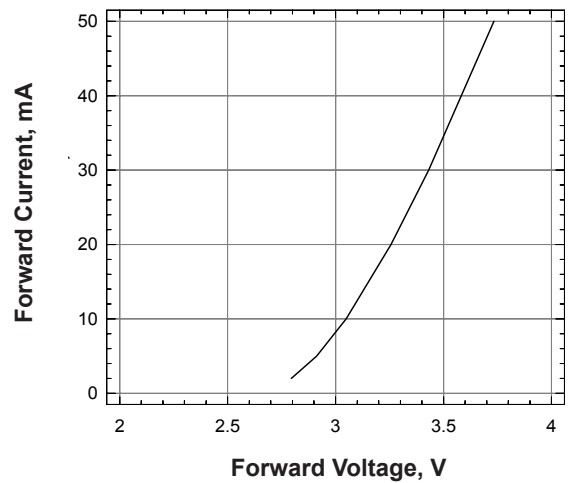

Maximum Current Vs Ambient Temperature

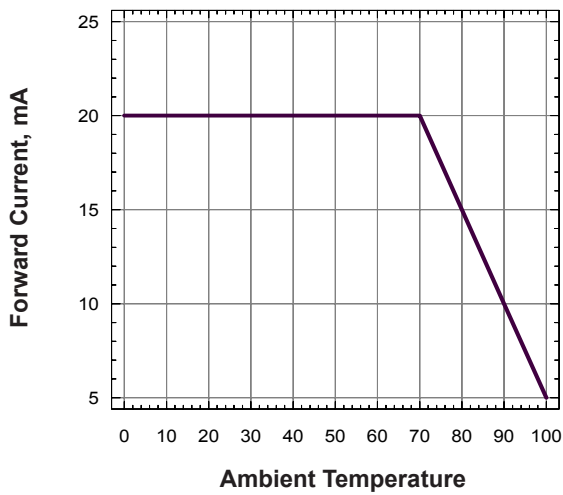

Relative Intensity Vs Wavelength

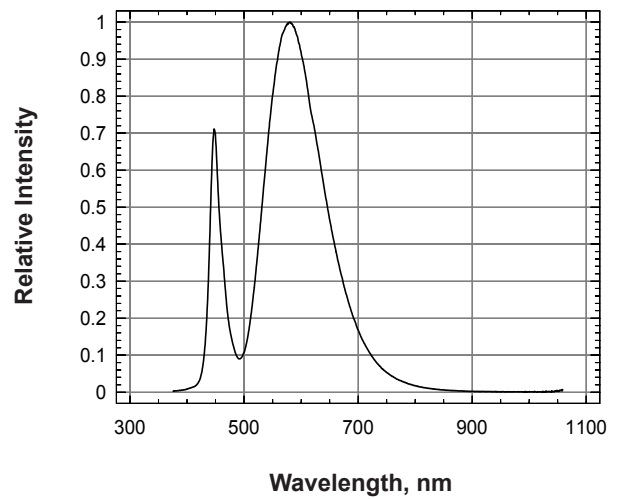

Radiation Pattern

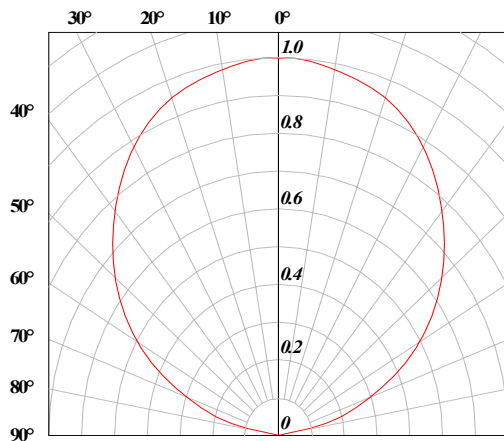

Mini DomiLED • InGaN Warm White: DNF-DJG-I5 Package Outlines

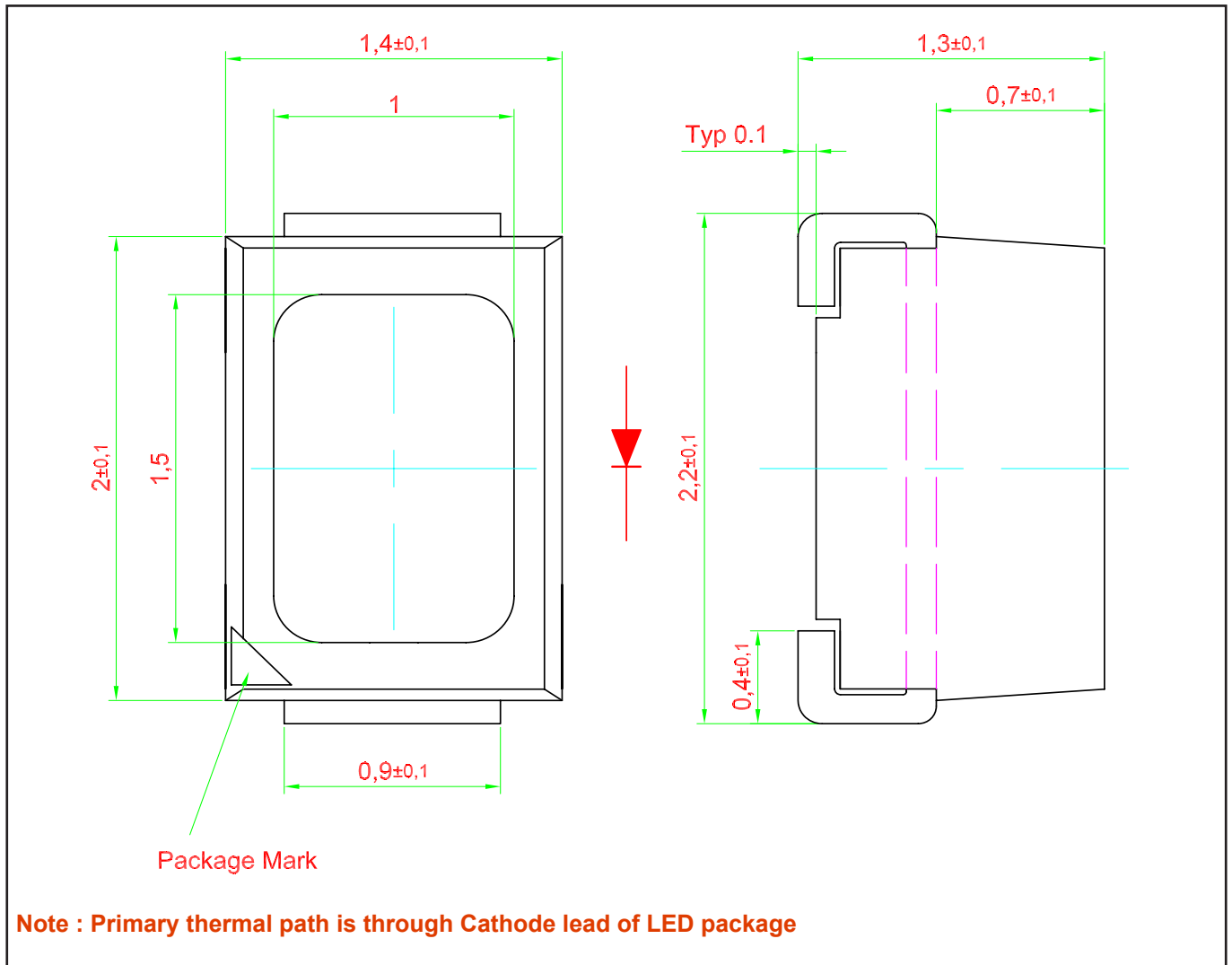

Material

Material	
Lead-frame	Cu Alloy With Ag Plating
Package	High Temperature Resistant Plastic, PPA
Encapsulant	Silicone
Soldering Leads	Sn Plating

Recommended Solder Pad

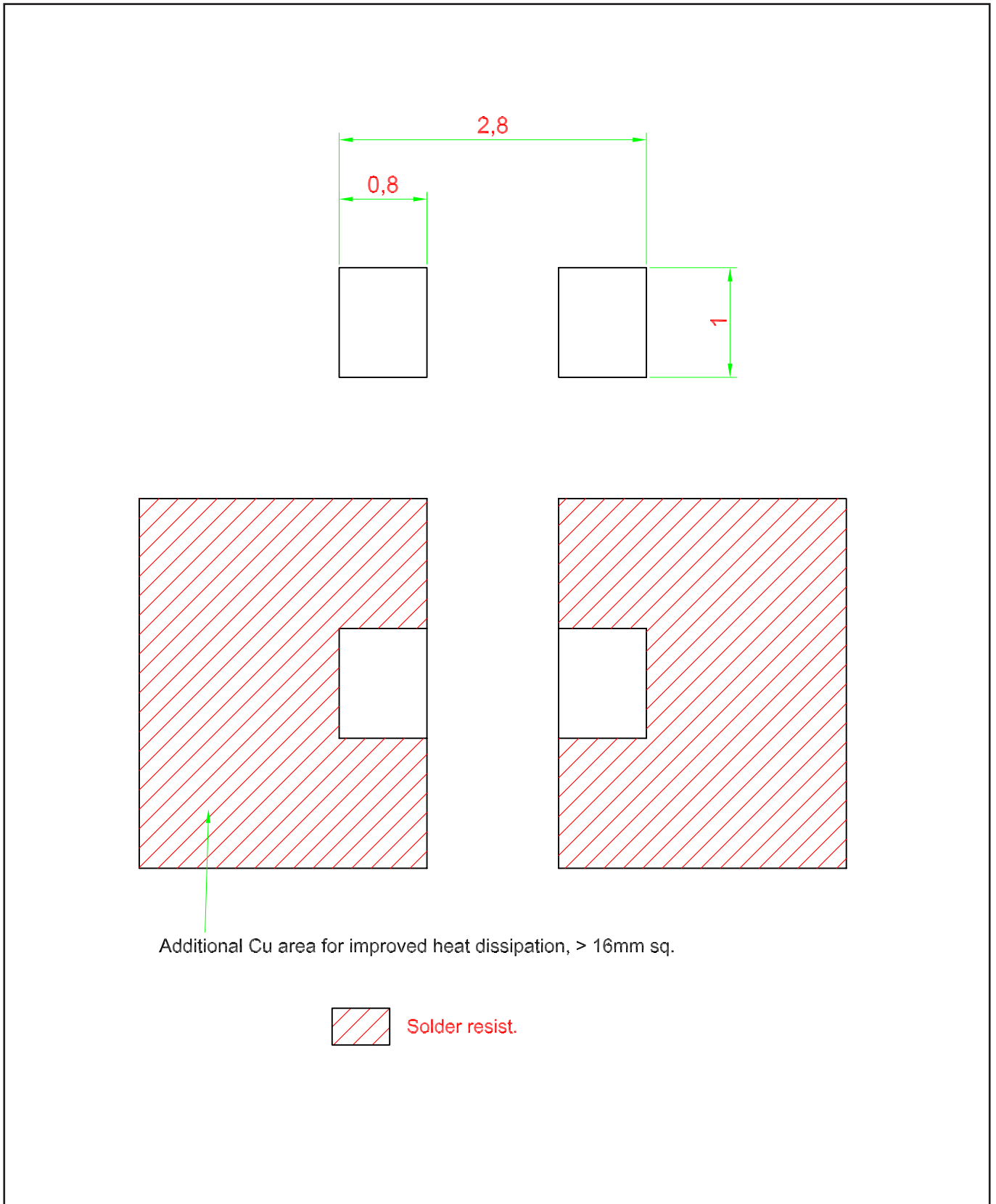

Taping and orientation

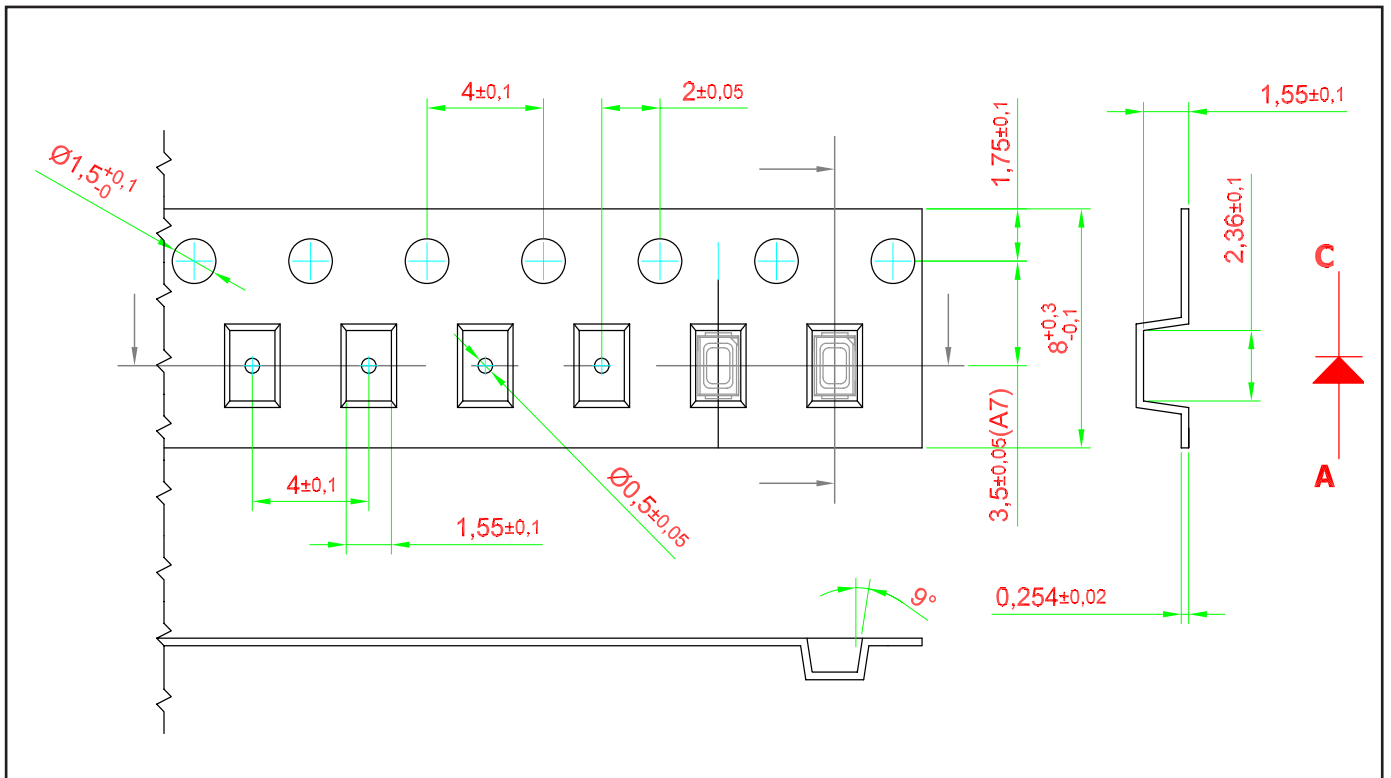

Packaging Specification

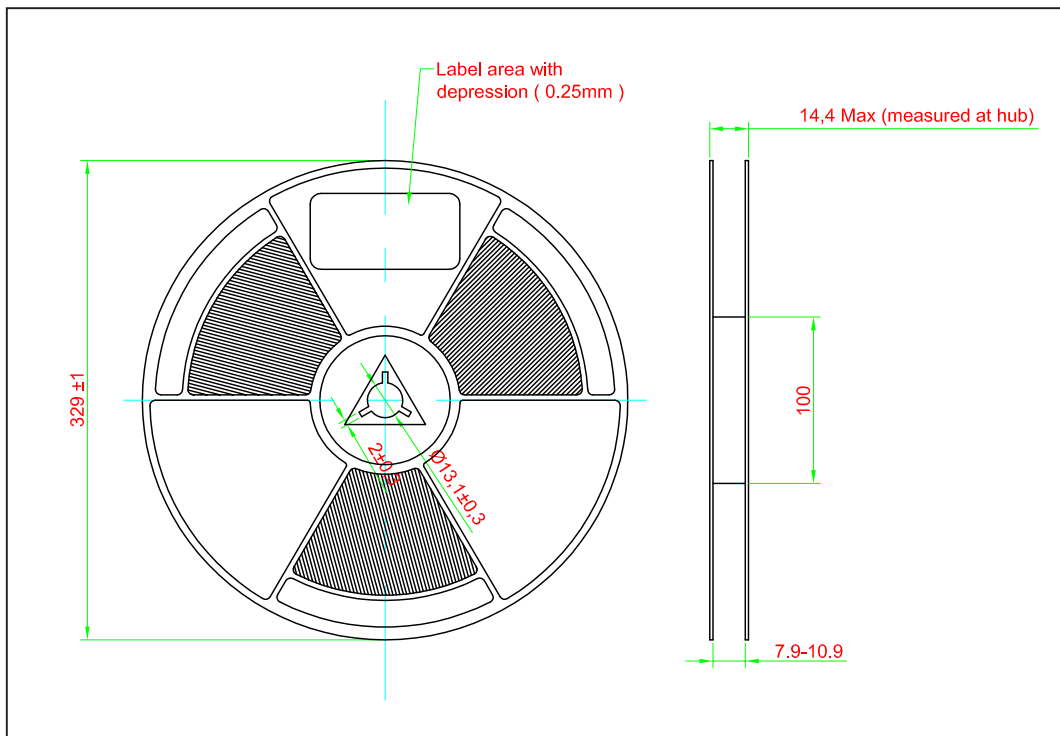
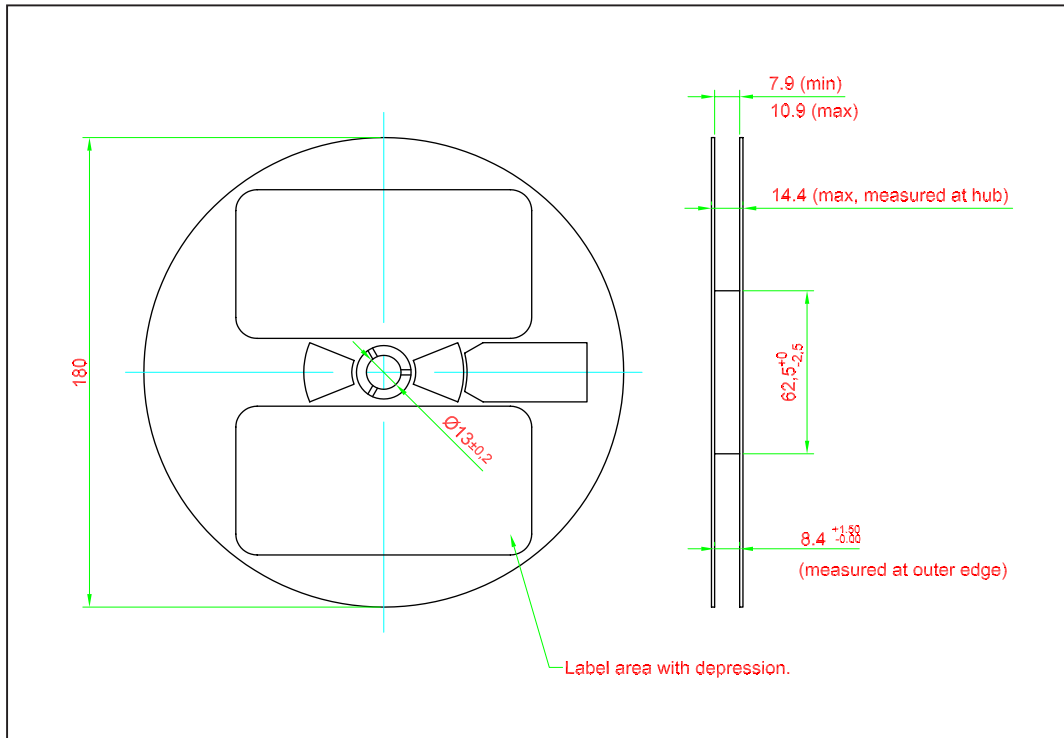

	Reel Diameter (mm)	Quantity (pcs)	Partno
Standard Packing	180	3000	DNF-DJG-xxx-x-I5
Optional Packing	329	10000	DNF-DJG-xxx-x-I5-J

Packaging Specification

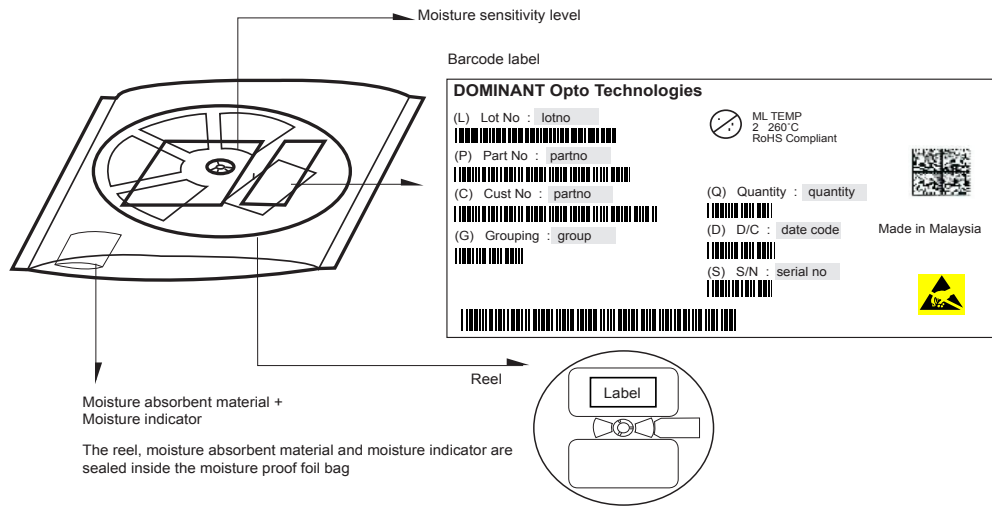

Quantity per bag (pcs)	Average 1pc Mini DomiLED (gram)	1 completed bag (gram)
3000	0.007	200 ± 10
10000	0.007	550 ± 10

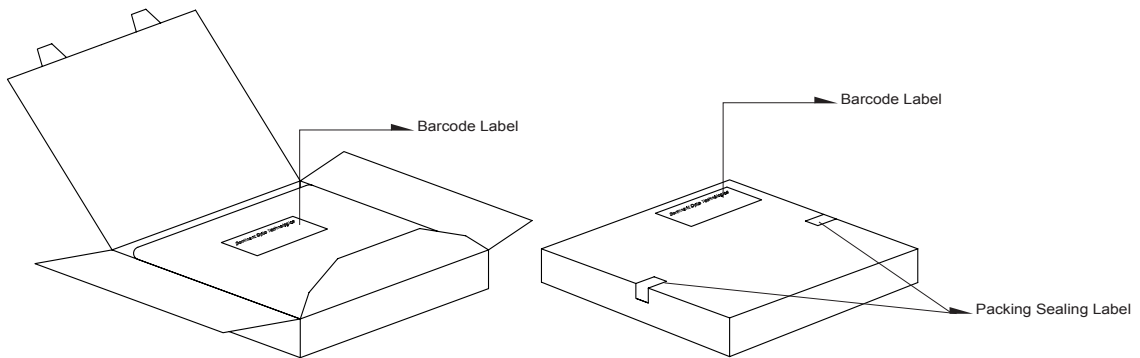

Reel Diameter (mm)	Packing Box Dimensions (mm)
180	210 x 210 x 16
329	345 x 345 x 16

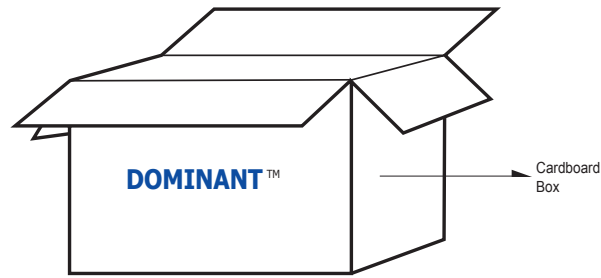

Reel Diameter (mm)	Cardboard Box Size	Dimensions (mm)	Empty Box Weight (kg)	Reel / Box
180	Super Small	325 x 225 x 190	0.38	9 reels MAX
180	Small	325 x 225 x 280	0.54	15 reels MAX
180	Medium	570 x 440 x 230	1.46	60 reels MAX
180	Large	570 x 440 x 460	1.92	120 reels MAX
329	Medium	373 x 373 x 285	1.02	13 reels MAX
329	Large	580 x 373 x 405	1.50	30 reels MAX

Recommended Pb-free Soldering Profile

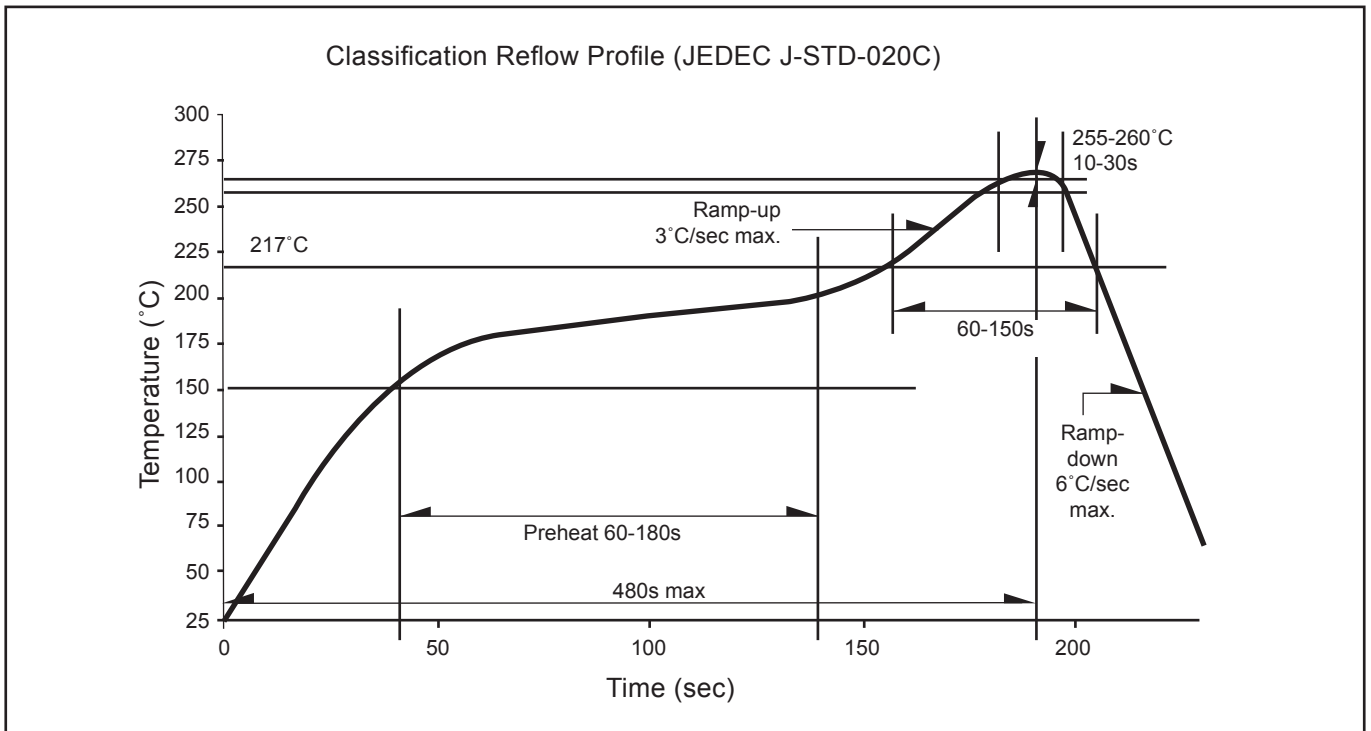

Appendix

1) **Brightness:**

- 1.1 Luminous intensity is measured at current pulse 25 ms(typ) with an internal reproducibility of $\pm 8\%$ and an expanded uncertainty of $\pm 11\%$ (according to GUM with a coverage factor of $k=3$).
- 1.2 Luminous flux is measured at current pulse 25 ms(typ) with an internal reproducibility of $\pm 8\%$ and an expanded uncertainty of $\pm 11\%$ (according to GUM with a coverage factor of $k=3$).
- 1.3 Radiant intensity is measured at current pulse 25 ms(typ) with an internal reproducibility of $\pm 8\%$ and an expanded uncertainty of $\pm 11\%$ (according to GUM with a coverage factor of $k=3$).
- 1.4 Radiant flux is measured at current pulse 25 ms(typ) with an internal reproducibility of $\pm 8\%$ and an expanded uncertainty of $\pm 11\%$ (according to GUM with a coverage factor of $k=3$).

2) **Color:**

- 2.1 Chromaticity coordinate groups are measured at current pulse 25 ms(typ) with an internal reproducibility of ± 0.005 and an expanded uncertainty of ± 0.01 (accordingly to GUM with a coverage factor of $k=3$).
- 2.2 Dominant wavelength is measured at current pulse 25 ms(typ) with an internal reproducibility of $\pm 0.5\text{nm}$ and an expanded uncertainty of $\pm 1\text{nm}$ (accordingly to GUM with a coverage factor of $k=3$).

3) **Voltage:**

- 3.1 Forward Voltage, V_f is measured when a current pulse of 8 ms(typ) with an internal reproducibility of $\pm 0.05\text{V}$ and an expanded uncertainty of $\pm 0.1\text{V}$ (accordingly to GUM with a coverage factor of $k=3$).

4) **Typical Values:**

- 4.1 At special conditions of LED manufacturing processes, typical data or calculated correlations of technical parameters only reflect the statistical figures. But not necessarily correspond to the actual parameters of each single product, which could differ from the typical data or calculated correlations or the typical characteristic line. These typical data may change whenever technical improvements happen.

5) **Tolerance of Measure**

- 5.1 Unless otherwise noted in drawing, tolerances are specified with ± 0.1 and dimension are specific in mm.

6) **Reverse Voltage:**

- 6.1 Not designed for reverse operation. Continuous reverse voltage can cause migration and LED damage.

7) **Corrosion Robustness:**

- 7.1 Test conditions: $40\text{ }^\circ\text{C} / 90\% \text{ rh} / 15 \text{ ppm H}_2\text{S} / 336 \text{ h}$.
= Stricter than IEC 60068-2-43 (H_2S) [$25\text{ }^\circ\text{C} / 75\% \text{ rh} / 10 \text{ ppm H}_2\text{S} / 21 \text{ days}$].

Revision History

Page	Subjects	Date of Modification
-	Initial Release	13 Oct 2015
1, 11, 15	Add Features Error on Taping and Orientation Add Appendix	06 Apr 2017
2	Add Notes: Minimum CRI of 80 Update Appendix	19 Oct 2017
12, 13, 14, 16	Update Package Specification Update Appendix	18 Jun 2020

NOTE

All the information contained in this document is considered to be reliable at the time of publishing. However, DOMINANT Opto Technologies does not assume any liability arising out of the application or use of any product described herein.

DOMINANT Opto Technologies reserves the right to make changes to any products in order to improve reliability, function or design.

DOMINANT Opto Technologies products are not authorized for use as critical components in life support devices or systems without the express written approval from the Managing Director of DOMINANT Opto Technologies.

About Us

DOMINANT Opto Technologies is a dynamic company that is amongst the world's leading automotive LED manufacturers. With an extensive industry experience and relentless pursuit of innovation, DOMINANT's state-of-art manufacturing and development capabilities have become a trusted and reliable brand across the globe. More information about DOMINANT Opto Technologies, a ISO/TS 16949 and ISO 14001 certified company, can be found under <http://www.dominant-semi.com>.

Please contact us for more information:

DOMINANT Opto Technologies Sdn. Bhd
Lot 6, Batu Berendam, FTZ Phase III, 75350 Melaka, Malaysia.
Tel: +606 283 3566 Fax: +606 283 0566
E-mail: sales@dominant-semi.com
