

Multi DomiLED

Synonymous with function and performance, the Multi DomiLED series is perfectly suited for a variety of cross-industrial applications due to its small package outline, durability and superior brightness.



Features:

- > High brightness tri-color surface mount LED.
- > Each color can be individually controlled
- > 120° viewing angle.
- > Small package outline (LxWxH) of 3.2 x 3.0 x 1.7mm.
- > Qualified according to JEDEC moisture sensitivity Level 2.
- > Compatible to IR reflow soldering.
- > Environmental friendly; RoHS compliance.
- > Superior Corrosion Resistant. *Appx. 7.1*
- > Compliance to automotive standard; AEC-Q102.

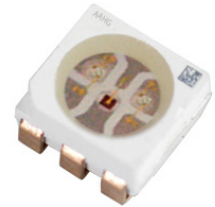

Applications:

- > Automotive: Interior applications, eg: ambient lighting

Optical Characteristics at Tj=25°C

Part Ordering Number	Color, λ_{dom} (nm)			Luminous Intensity @ If = 20mA IV (mcd) <i>Appx. 1.1</i>		
	Chip #1	Chip #2	Chip #3	Chip #1	Chip #2	Chip #3
D6RTB-EKG-U2V+W2X+S3T3-1	Red 626nm	True Green 528nm	Blue 452nm	560.0-1125.0	1400.0-2850.0	200.0-350.0

Electrical Characteristics at Tj=25°C

	$V_f @ I_f = 20mA$ <i>Appx. 3.1</i>			$V_r @ I_r = 10\mu A$ <i>Appx. 6.1</i>
	Min. (V)	Typ. (V)	Max. (V)	Min. (V)
Red	1.80	2.10	2.40	12
True Green	2.65	3.00	3.30	5
Blue	2.65	3.00	3.30	5

Absolute Maximum Ratings

	Maximum Value	Unit
DC forward current	Red; AllInGaP=50; True Green, Blue; InGaN=50	mA
Peak pulse current; (tp ≤ 10μs, Duty cycle = 0.005)	Red ; AllInGaP=200 True Green, Blue; InGaN=200	mA
Reverse voltage <i>Appx. 6.1</i>	Red; AllInGaP=12; True Green, Blue; InGaN= 5	V
ESD threshold (HBM)	2000	V
LED junction temperature	125	°C
Operating temperature	-40 ... +115	°C
Storage temperature	-40 ... +125	°C
Thermal resistance (1 chips on) (Rated current = 20mA, Ts = 25 °C)		
- Real Thermal Resistance		
Junction / solder point, R _{th JS real}		
Red (typ=86)	110	K/W
Blue & True Green (typ=130)	155	K/W
(Mounting on DOMINANT standard PCB)		

D6RTB-EKG, Color Grouping at Tj=25°C Appx. 2.1

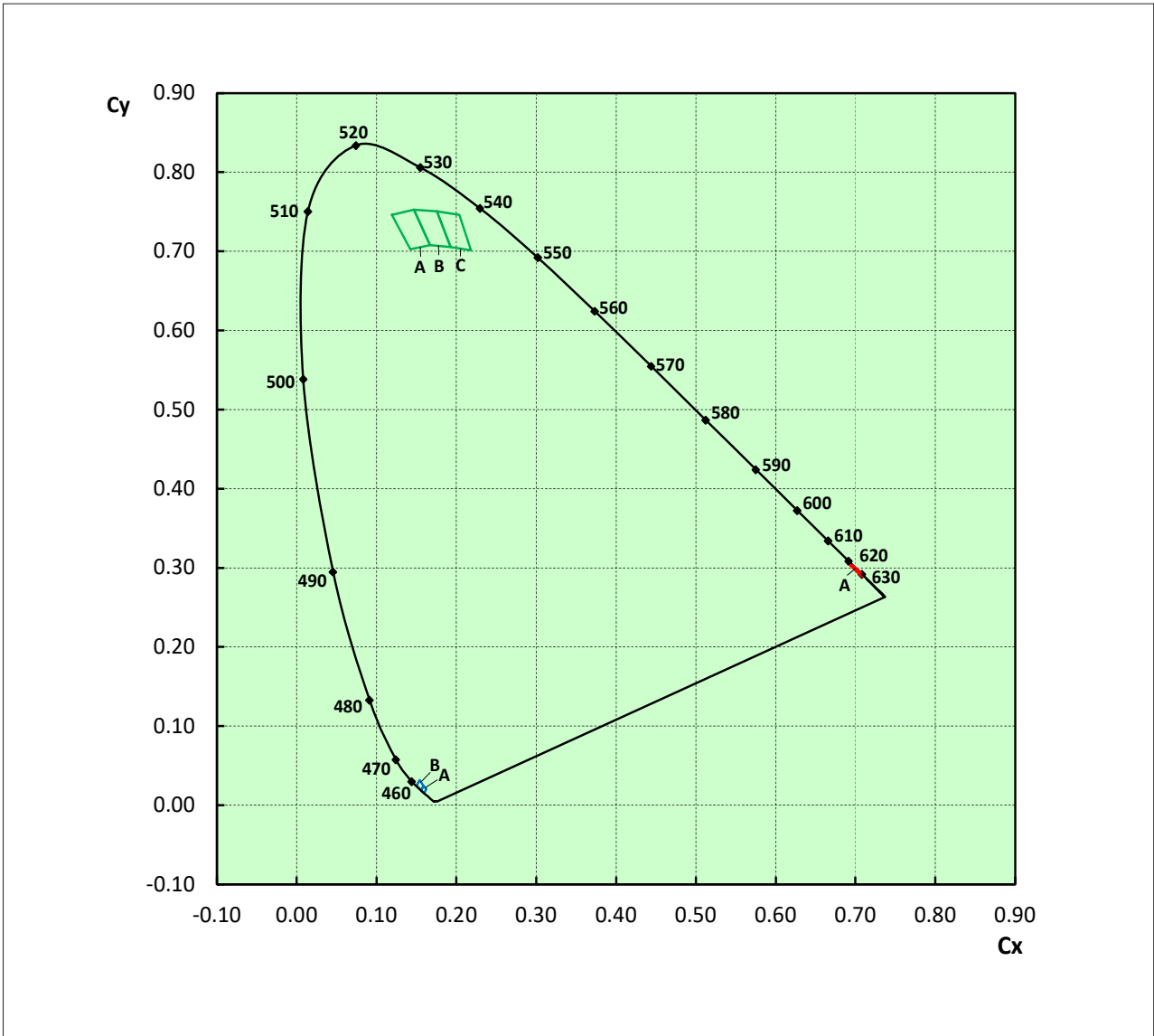

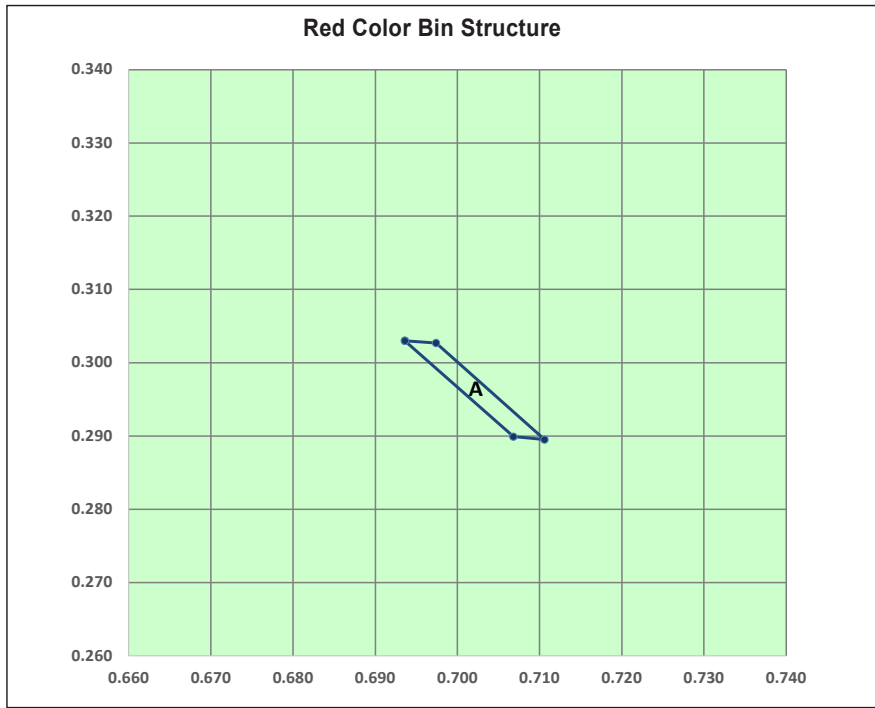

Red

Bin		1	2	3	4
A	Cx	0.6936	0.6974	0.7106	0.7068
	Cy	0.3030	0.3027	0.2895	0.2899

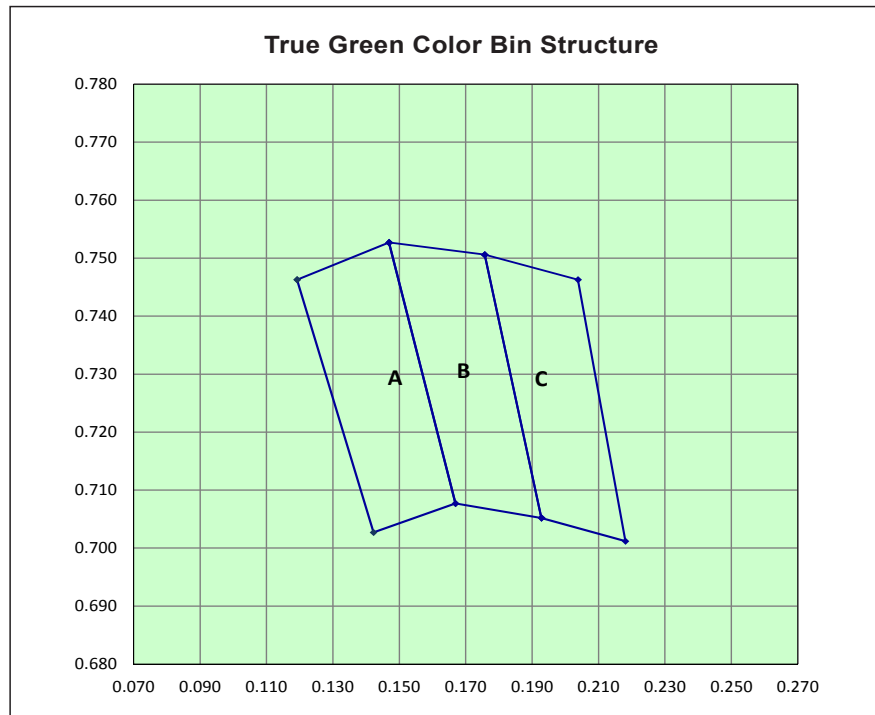

True Green

Bin		1	2	3	4
A	Cx	0.1192	0.1469	0.1669	0.1422
	Cy	0.7463	0.7527	0.7077	0.7027
B	Cx	0.1469	0.1757	0.1928	0.1669
	Cy	0.7527	0.7506	0.7052	0.7077
C	Cx	0.1757	0.2038	0.2181	0.1928
	Cy	0.7506	0.7463	0.7012	0.7052

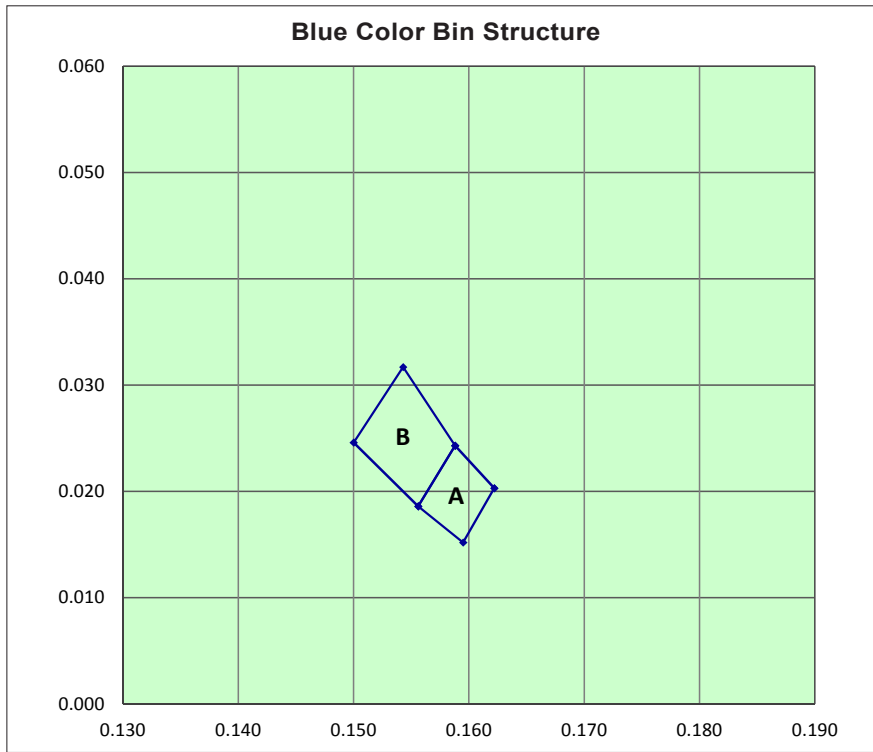

Blue

Bin		1	2	3	4
A	Cx	0.1622	0.1595	0.1556	0.1588
	Cy	0.0203	0.0152	0.0186	0.0243
B	Cx	0.1588	0.1556	0.1500	0.1543
	Cy	0.0243	0.0186	0.0246	0.0317

Luminous Intensity Group at Tj=25°C

Color	Brightness Group	Luminous Intensity <small>Appx. 1.1</small> IV (mcd)
Red	U2	560.0 ... 715.0
	V1	715.0 ... 900.0
	V2	900.0 ... 1125.0
True Green	W2	1400.0 ... 1800.0
	X1	1800.0 ... 2240.0
	X2	2240.0 ... 2850.0
Blue	S3	200.0 ... 275.0
	T3	275.0 ... 350.0

Relative Luminous Intensity Vs Forward Current (Red)
 $I_V/I_V(20mA) = f(I_F); T_j = 25^\circ C$

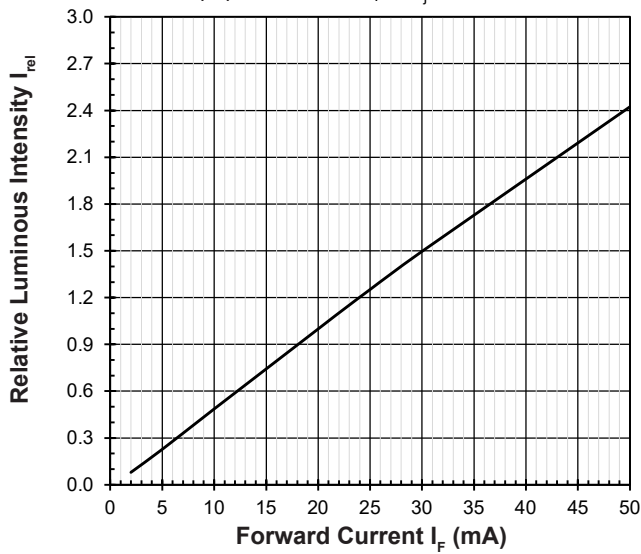

Relative Luminous Intensity Vs Forward Current (Blue & True Green)
 $I_V/I_V(20mA) = f(I_F); T_j = 25^\circ C$

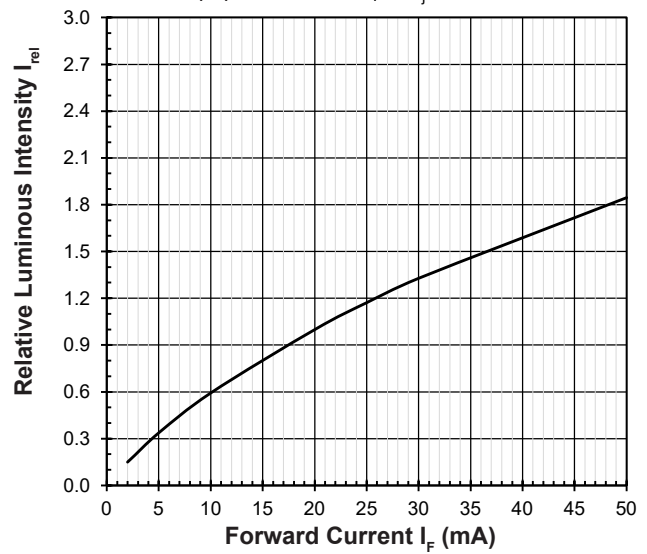

Forward Current Vs Forward Voltage (Red)
 $I_F = f(V_F); T_j = 25^\circ C$

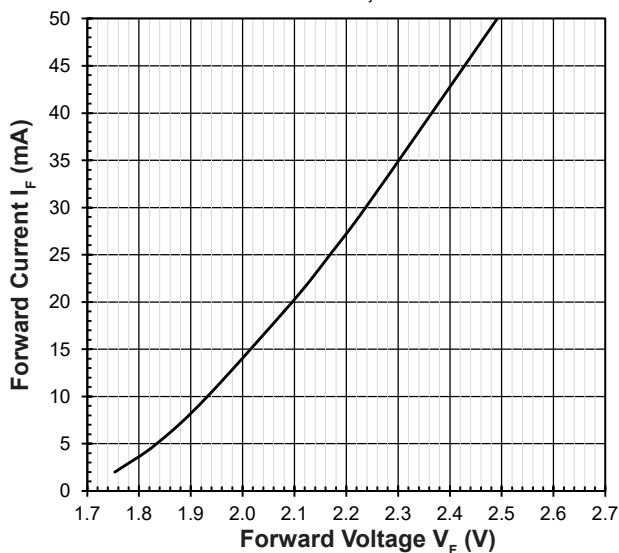

Forward Current Vs Forward Voltage (Blue & True Green)
 $I_F = f(V_F); T_j = 25^\circ C$

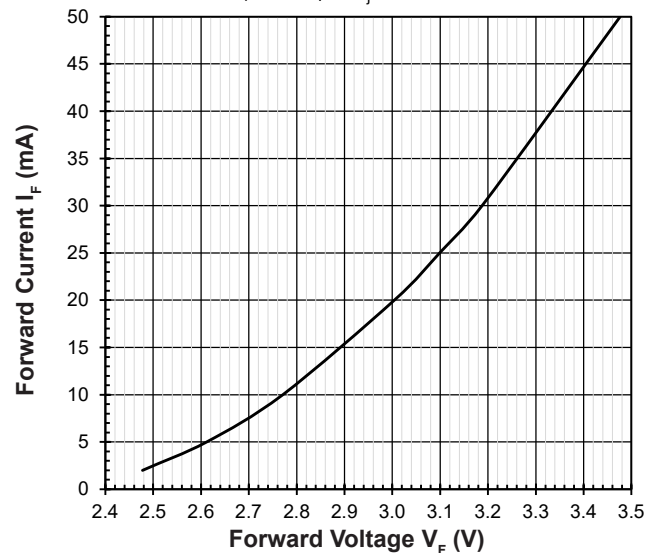

Maximum Current Vs Temperature (Red) (1 chip on)
 $I_F = f(T)$

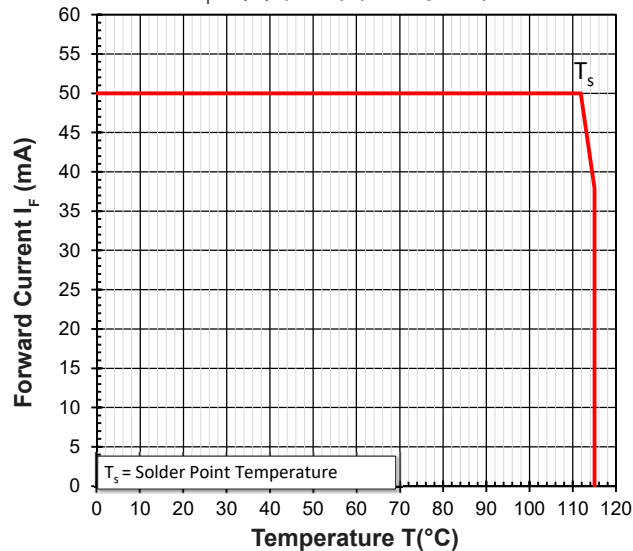

Maximum Current Vs Temperature (Blue & True Green) (1 chip on)
 $I_F = f(T)$

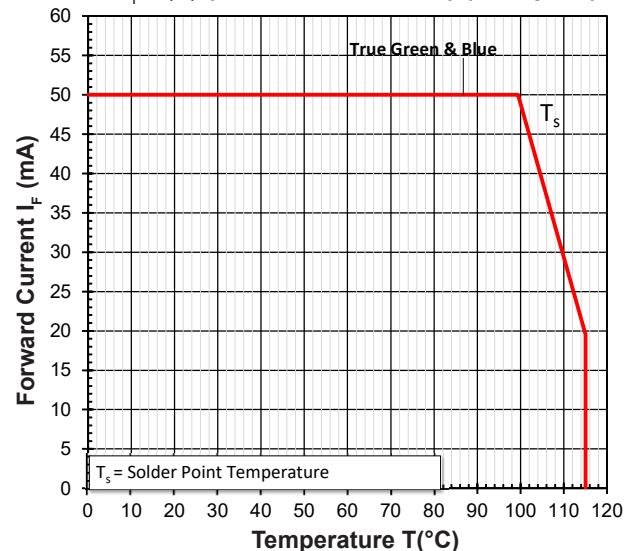

Relative Spectral Emission

$I_{rel} = f(\lambda); T_j = 25^\circ\text{C}; I_F = 20\text{mA}$

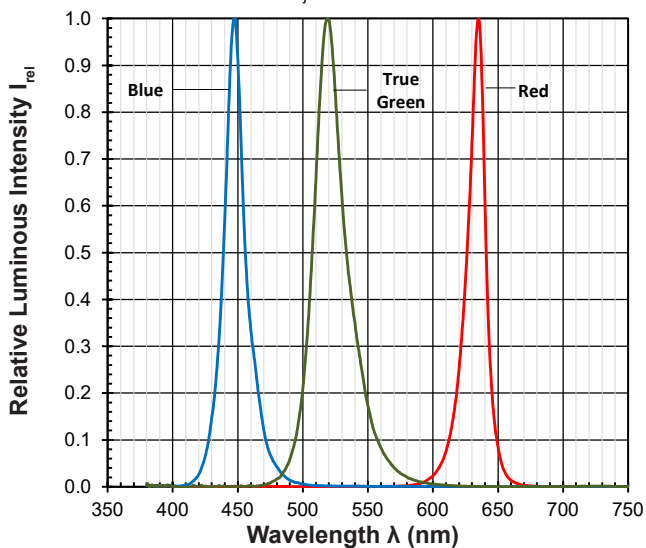

Chromaticity Coordinate Shift Vs Forward Current

$\Delta Cx, \Delta Cy = f(I_F); T_j = 25^\circ\text{C} \text{ (Red)}$

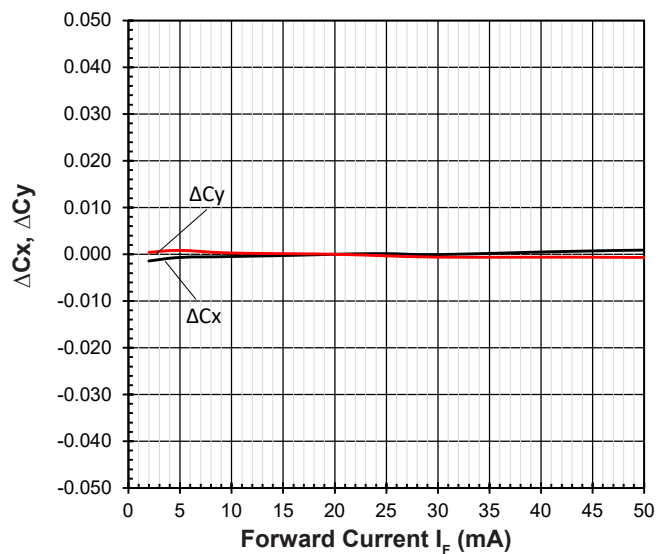

Chromaticity Coordinate Shift Vs Forward Current

$\Delta Cx, \Delta Cy = f(I_F); T_j = 25^\circ\text{C} \text{ (True Green)}$

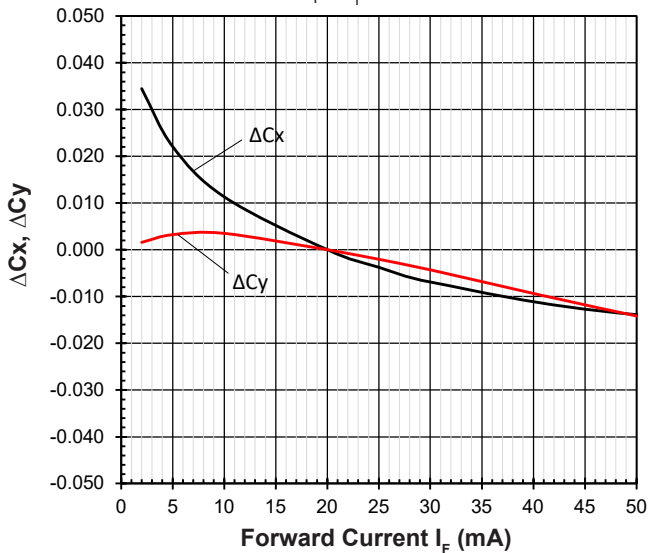

Chromaticity Coordinate Shift Vs Forward Current

$\Delta Cx, \Delta Cy = f(I_F); T_j = 25^\circ\text{C} \text{ (Blue)}$

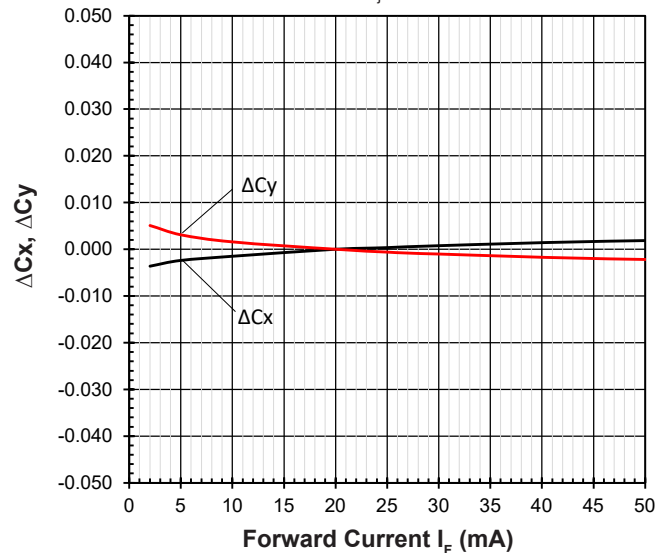

Allowable Forward Current Vs Duty Ratio

$(T_s = 55^\circ\text{C}; t_p = 100\mu\text{s})$



Radiation Pattern

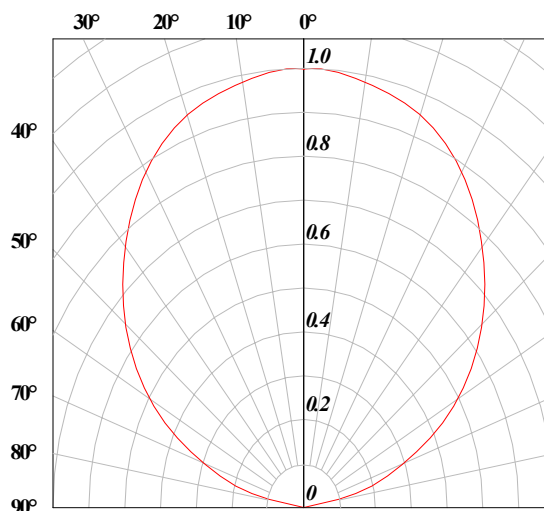

Relative Forward Voltage Vs Junction Temperature

$\Delta V_F = V_F - V_F(25^\circ\text{C}) = f(T_j); I_F = 20\text{mA}$

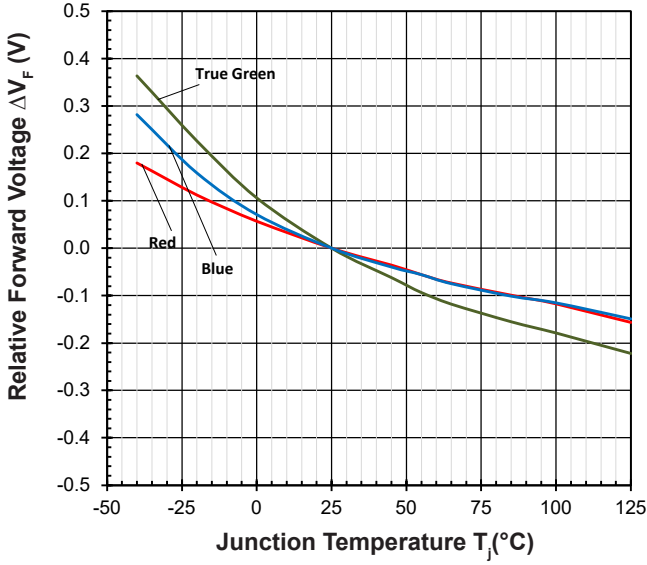

Relative Luminous Intensity Vs Junction Temperature

$I_V/I_V(25^\circ\text{C}) = f(T_j); I_F = 20\text{mA}$

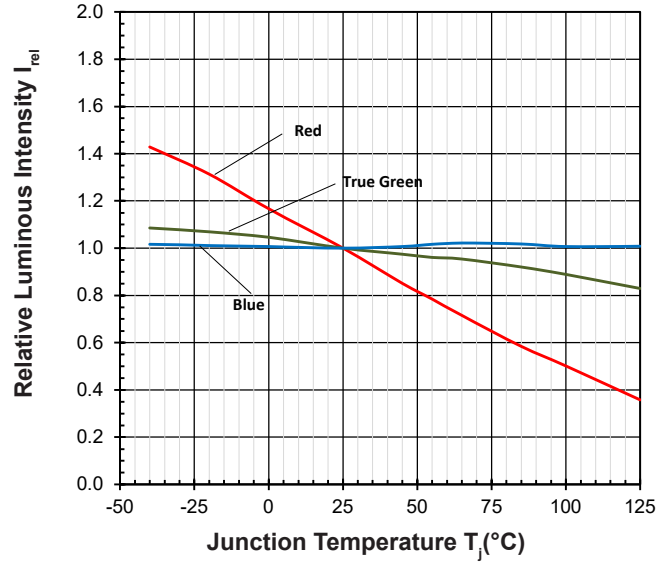

Chromaticity Coordinate Shift Vs Junction Temperature

$\Delta C_x, \Delta C_y = f(T_j); I_F = 20\text{mA (Red)}$

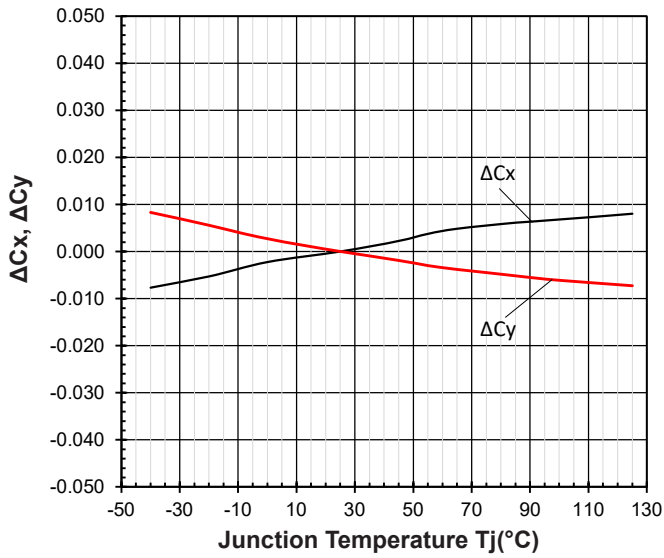

Chromaticity Coordinate Shift Vs Junction Temperature

$\Delta C_x, \Delta C_y = f(T_j); I_F = 20\text{mA (True Green)}$

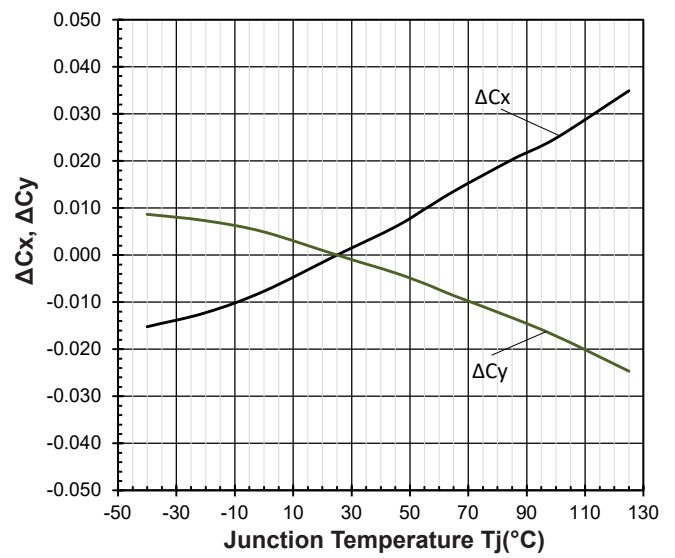

Chromaticity Coordinate Shift Vs Junction Temperature

$\Delta C_x, \Delta C_y = f(T_j); I_F = 20\text{mA (Blue)}$

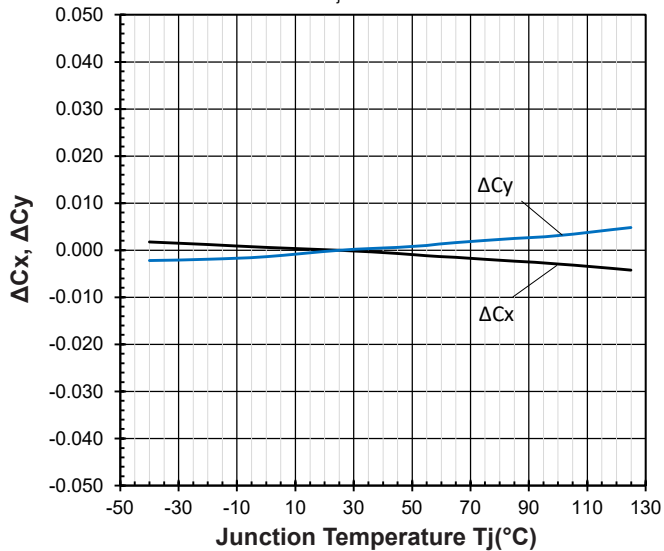

Multi DomiLED : D6RTB-EKG Package Outlines

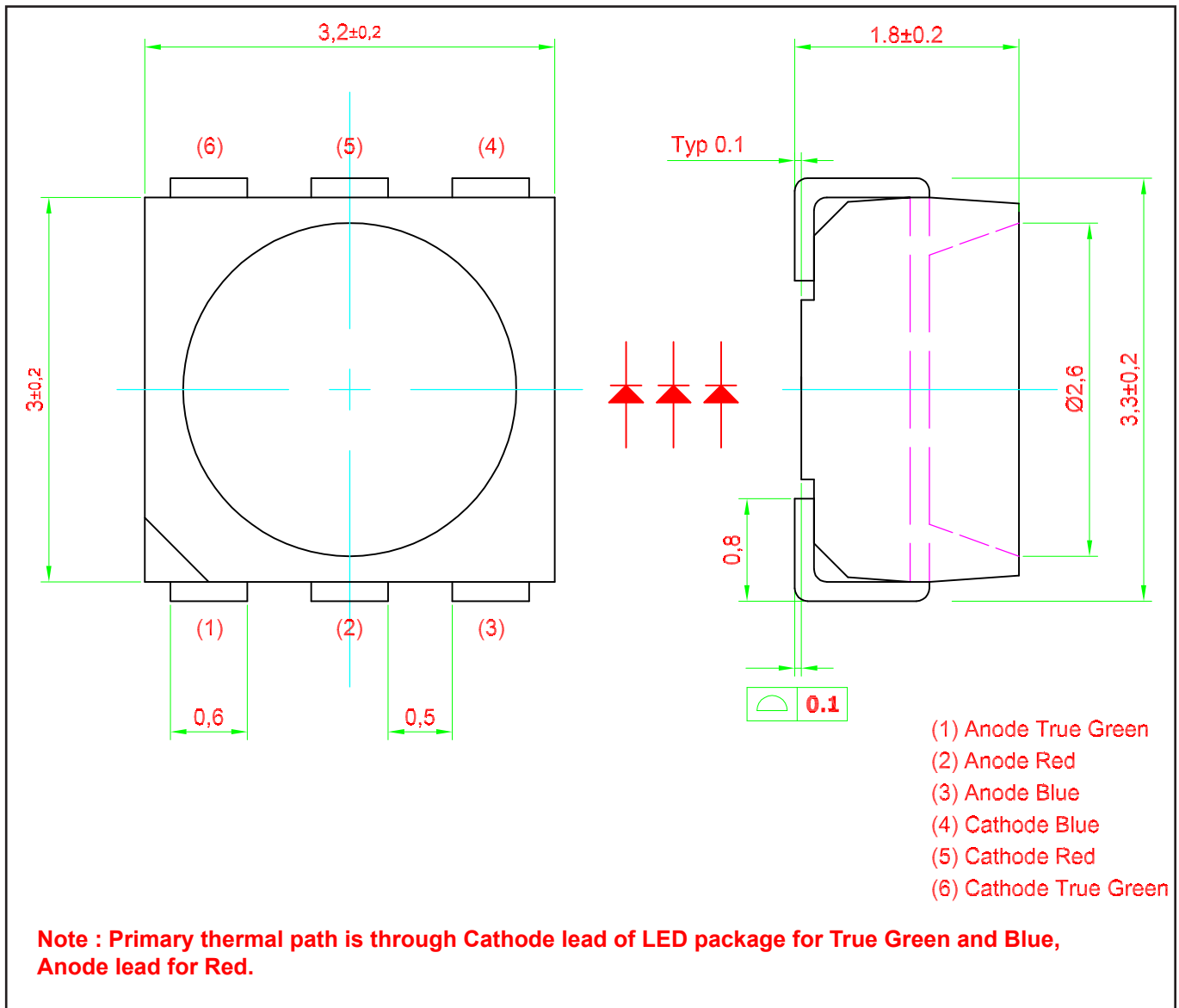

Materials

Materials	
Lead Frame	Cu Alloy with NipdAu Plating
Housing	High temperature resistant plastic, PPA
Encapsulant	Silicone
Lead-finishing	NipdAu Plating

Note: Package is Pb-free.

Recommended Solder Pad

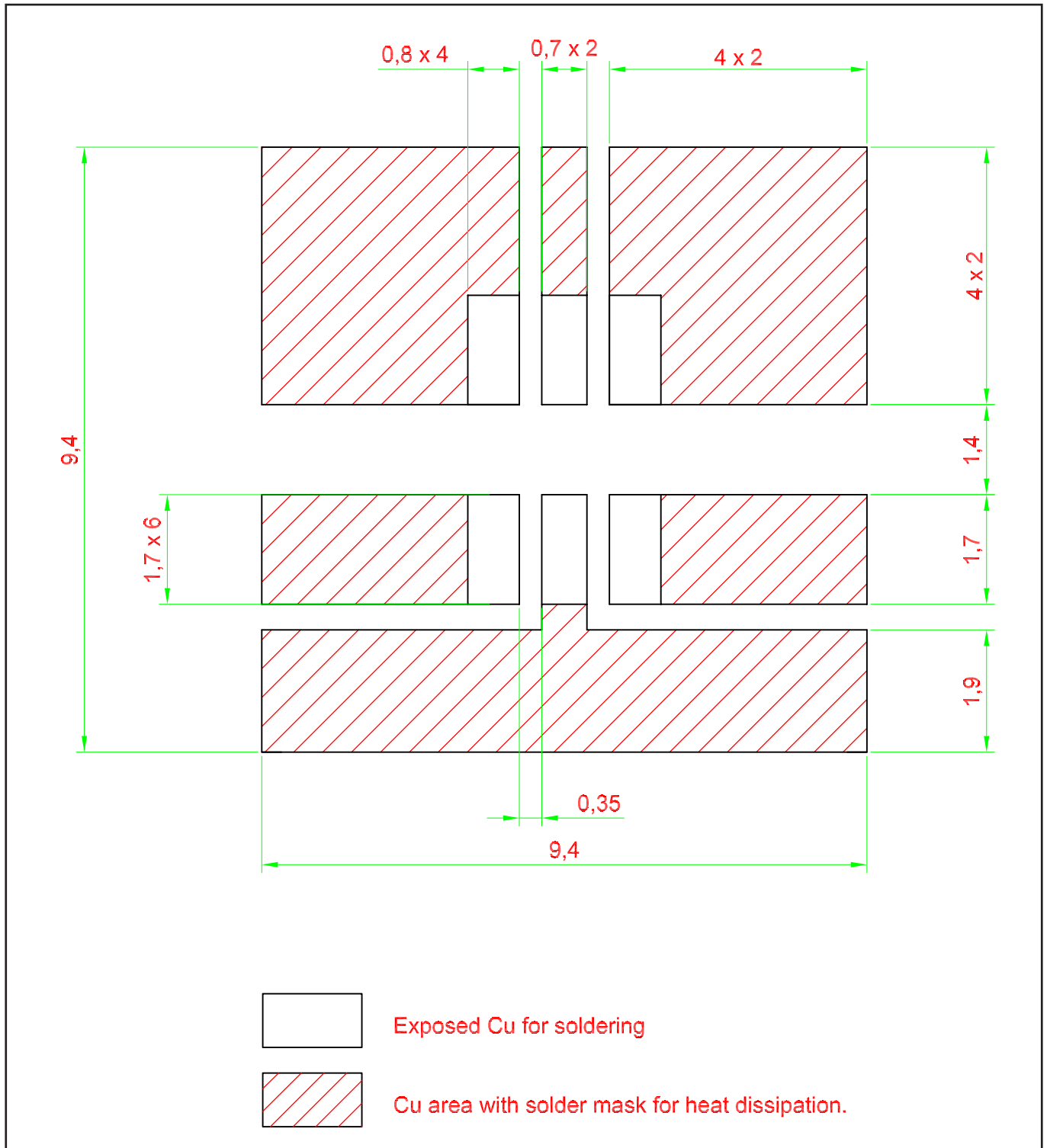

Taping and orientation

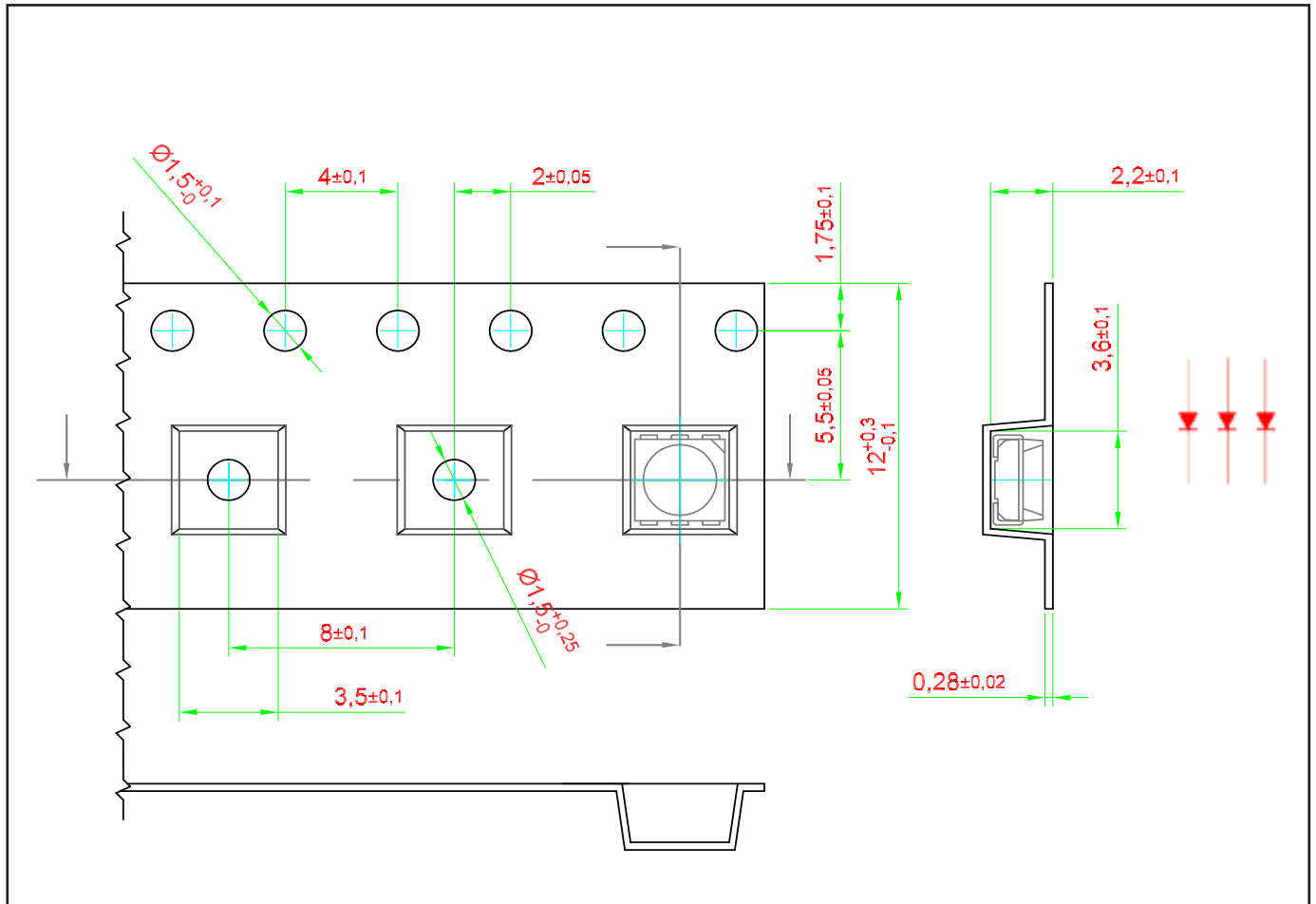

Packaging Specification

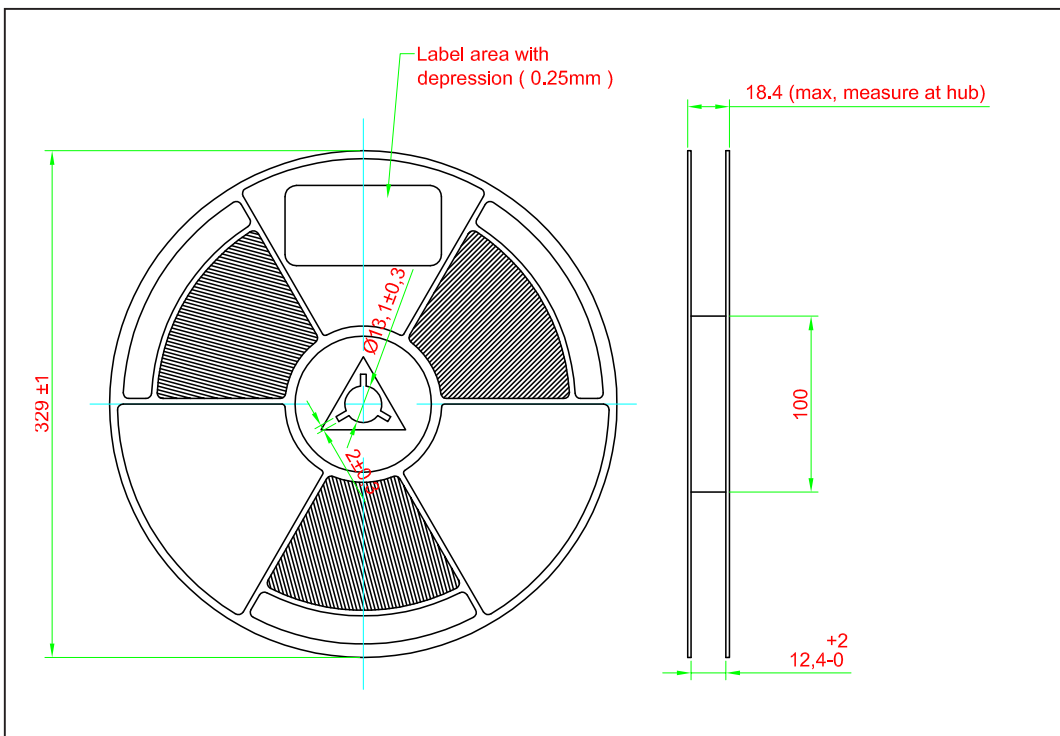
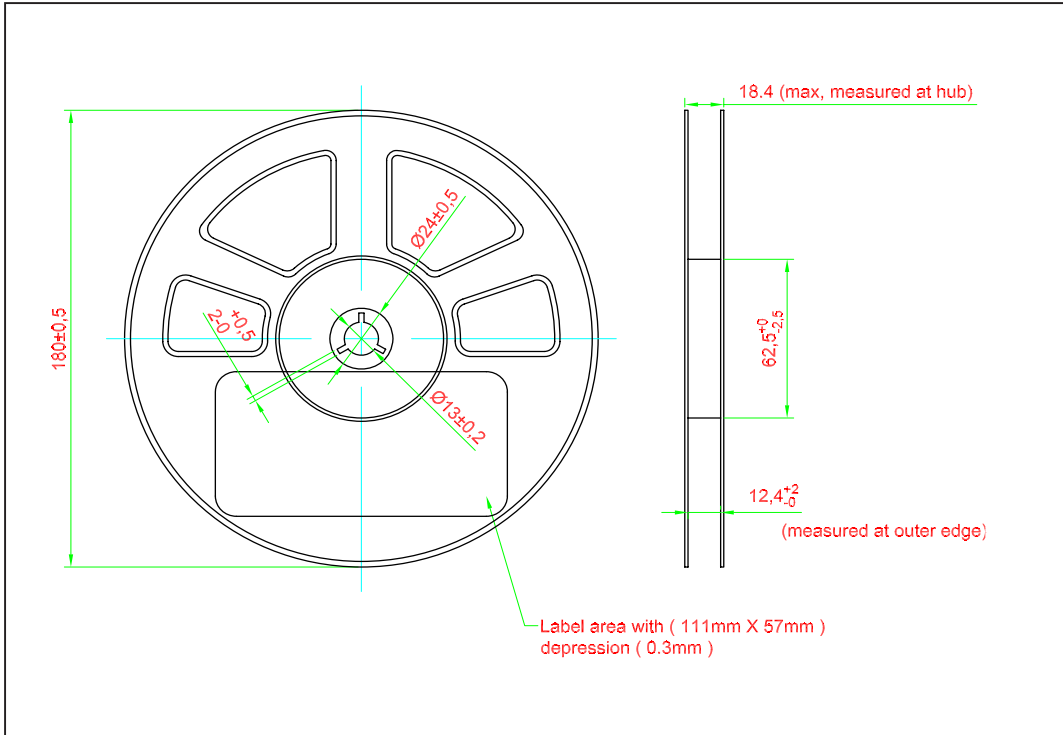

	Reel Diameter (mm)	Quantity (pcs)	Partno
Standard Packing	180	1000	D6RTB-EKG-XXX+XXX+XXX-X
Optional Packing	329	4000	D6RTB-EKG-XXX+XXX+XXX-X-4

Packaging Specification

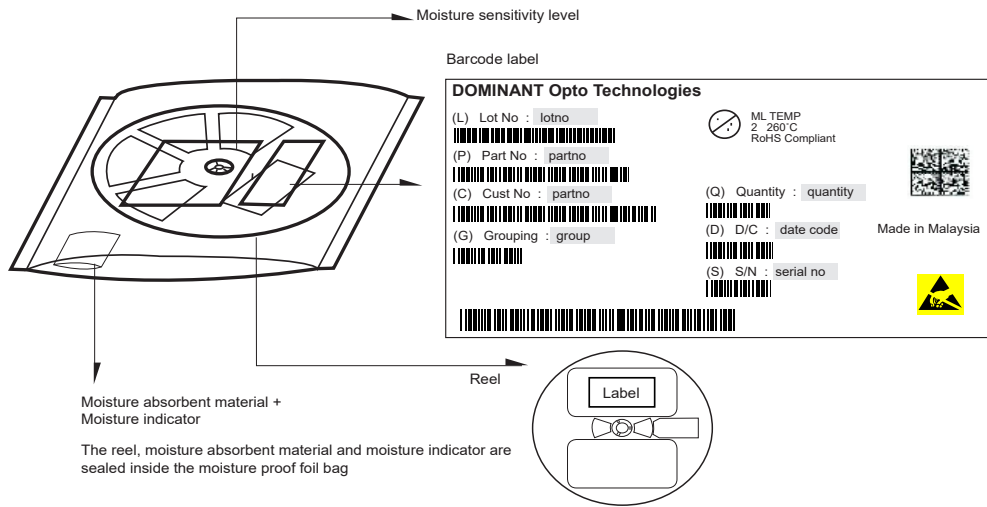

Quantity per bag (pcs)	Average 1pc Multi DomiLED (gram)	1 completed bag (gram)
1000	0.034	240 ± 10
4000	0.034	750 ± 10

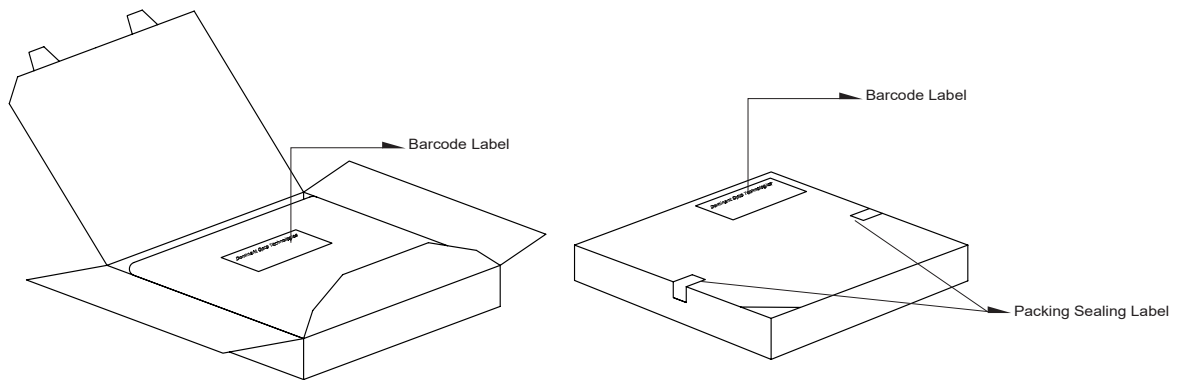

Reel Diameter (mm)	Packing Box Dimensions (mm)
180	210 x 210 x 20
329	345 x 345 x 20

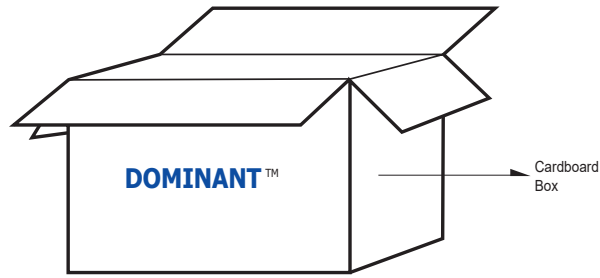

Reel Diameter (mm)	Cardboard Box Size	Dimensions (mm)	Empty Box Weight (kg)	Reel / Box
180	Super Small	325 x 225 x 190	0.38	7 reels MAX
180	Small	325 x 225 x 280	0.54	11 reels MAX
180	Medium	570 x 440 x 230	1.46	48 reels MAX
180	Large	570 x 440 x 460	1.92	96 reels MAX
329	Medium	373 x 373 x 285	1.02	12 reels MAX
329	Large	580 x 373 x 405	1.50	25 reels MAX

Recommended Pb-free Soldering Profile

Product complies to MSL Level 2 acc. to JEDEC J-STD-20E

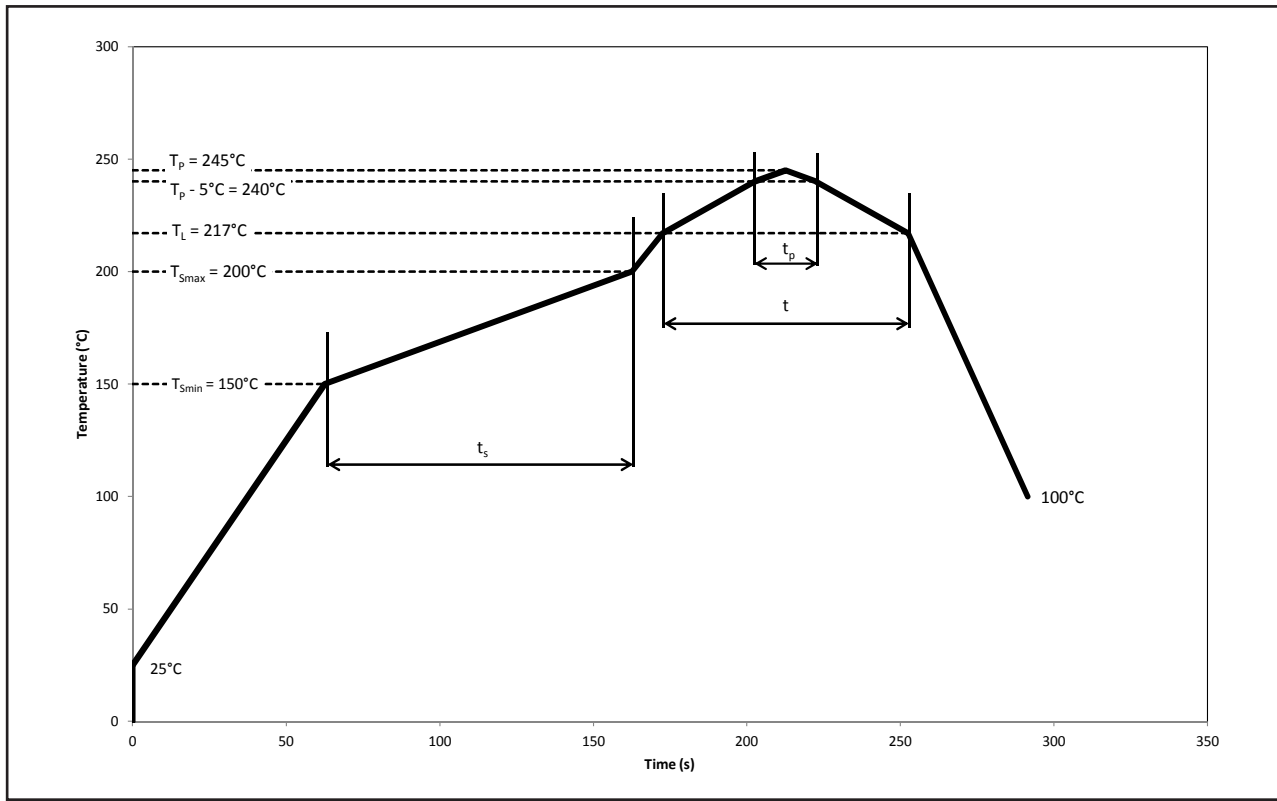

Profile Feature	Symbol	Pb-Free Assembly			Unit
		Min.	Recommended	Max.	
Ramp-up rate to preheat 25°C to T_{smin}	-	-	2	3	°C/s
Time t_s T_{smin} to T_{smax}	t_s	60	100	120	s
Ramp-up rate to peak T_L to T_p	-	-	2	3	°C/s
Liquidous temperature	T_L	-	217	-	°C
Time above liquidous temperature	t	60	80	150	s
Peak temperature	T_p	-	245	260	°C
Time within 5°C of the specified peak temperature $T_p - 5°C$	T_p	10	20	30	s
Ramp-down rate T_p to 100°C	-	-	3	6	°C/s
Time 25°C to T_p	-	-	-	480	s

Appendix

1) **Brightness:**

- 1.1 Luminous intensity is measured at current pulse 25 ms(typ) with an internal reproducibility of $\pm 8\%$ and an expanded uncertainty of $\pm 11\%$ (according to GUM with a coverage factor of $k=3$).
- 1.2 Luminous flux is measured at current pulse 25 ms(typ) with an internal reproducibility of $\pm 8\%$ and an expanded uncertainty of $\pm 11\%$ (according to GUM with a coverage factor of $k=3$).
- 1.3 Radiant intensity is measured at current pulse 25 ms(typ) with an internal reproducibility of $\pm 8\%$ and an expanded uncertainty of $\pm 11\%$ (according to GUM with a coverage factor of $k=3$).
- 1.4 Radiant flux is measured at current pulse 25 ms(typ) with an internal reproducibility of $\pm 8\%$ and an expanded uncertainty of $\pm 11\%$ (according to GUM with a coverage factor of $k=3$).

2) **Color:**

- 2.1 Chromaticity coordinate groups are measured at current pulse 25 ms(typ) with an internal reproducibility of ± 0.005 and an expanded uncertainty of ± 0.01 (accordingly to GUM with a coverage factor of $k=3$).
- 2.2 Dominant wavelength is measured at current pulse 25 ms(typ) with an internal reproducibility of $\pm 0.5\text{nm}$ and an expanded uncertainty of $\pm 1\text{nm}$ (accordingly to GUM with a coverage factor of $k=3$).

3) **Voltage:**

- 3.1 Forward Voltage, V_f is measured when a current pulse of 8 ms(typ) with an internal reproducibility of $\pm 0.05\text{V}$ and an expanded uncertainty of $\pm 0.1\text{V}$ (accordingly to GUM with a coverage factor of $k=3$).

4) **Typical Values:**

- 4.1 At special conditions of LED manufacturing processes, typical data or calculated correlations of technical parameters only reflect the statistical figures. But not necessarily correspond to the actual parameters of each single product, which could differ from the typical data or calculated correlations or the typical characteristic line. These typical data may change whenever technical improvements happen.

5) **Tolerance of Measure**

- 5.1 Unless otherwise noted in drawing, tolerances are specified with ± 0.1 and dimension are specified in mm.

6) **Reverse Voltage:**

- 6.1 Not designed for reverse operation. Continuous reverse voltage can cause migration and LED damage.

7) **Corrosion Robustness:**

- 7.1 Test conditions: $40\text{ }^\circ\text{C} / 90\% \text{ rh} / 15 \text{ ppm H}_2\text{S} / 336 \text{ h}$.
= Stricter than IEC 60068-2-43 (H_2S) [$25\text{ }^\circ\text{C} / 75\% \text{ rh} / 10 \text{ ppm H}_2\text{S} / 21 \text{ days}$].

About Us

DOMINANT Opto Technologies is a dynamic company that is amongst the world's leading automotive LED manufacturers. With an extensive industry experience and relentless pursuit of innovation, DOMINANT's state-of-art manufacturing and development capabilities have become a trusted and reliable brand across the globe. More information about DOMINANT Opto Technologies, an IATF 16949 and ISO 14001 certified company, can be found under <http://www.dominant-semi.com>.

Please contact us for more information:

DOMINANT Opto Technologies Sdn. Bhd.
Lot 6, Batu Berendam, FTZ Phase III, 75350 Melaka, Malaysia
Tel: (606) 283 3566 Fax: (606) 283 0566
E-mail: sales@dominant-semi.com